

ENGLISH

Infinity iS-200

Ordercode: 41501

Table of contents

Warning	2
Safety Instructions	2
Operating Determinations	4
Rigging	4
Return Procedure	6
Claims	6
Description of the device	7
Overview	8
Backside	8
Installation	9
Set Up and Operation	9
Control Modes	9
One Infinity (Built-in Programs)	9
Multiple Infinity's (Master/Slave control)	9
Multiple Infinity's (DMX Control)	10
Fixture Linking	11
Data Cabling	11
Control Panel	12
Control Mode	12
DMX Addressing	12
Menu Overview	13
Main Menu Options	14
1. DMX Addressing	14
2. Edit Mode	15
3. Settings Menu	15
4. Built-in Programs	16
5. Test Menu	17
6. Information Menu	18
DMX Channels	19
21 Channels (Advanced)	19
18 Channels (Basic)	24
Channel settings	27
Maintenance	28
Replacing a Fuse	28
Replacing a Gobo from the rotating Gobowheel	28
Battery Replacement	31
Troubleshooting	32
Product Specification	34

Warning

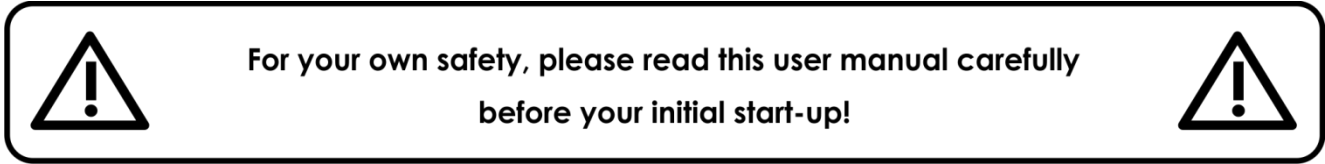

Unpacking Instructions

Immediately upon receiving this product, carefully unpack the carton and check the contents to ensure that all parts are present, and have been received in good condition. Notify the dealer immediately and retain packing material for inspection if any parts appear damaged from shipping or the carton itself shows signs of mishandling. Save the carton and all packing materials. In the event that a fixture must be returned to the factory, it is important that the fixture be returned in the original factory box and packing.

Your shipment includes:

- Infinity iS-200 LED Spot with Powercon powercable 0,9m
- 2 brackets for truss mounting
- Safety eye
- User manual

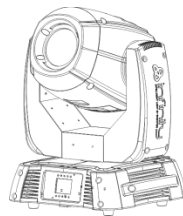
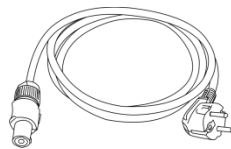
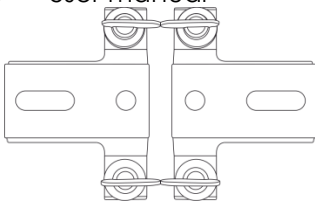

LED Expected Lifespan

LEDs gradually decline in brightness over time. HEAT is the dominant factor that leads to the acceleration of this decline. Packaged in clusters, LEDs exhibit higher operating temperatures than in ideal or singular optimum conditions. For this reason when all color LEDs are used at their fullest intensity, life of the LEDs is significantly reduced. If improving your lifespan expectancy is of a higher priority, place care in providing for lower operational temperatures. This may include climatic-environmental and the reduction of overall projection intensity

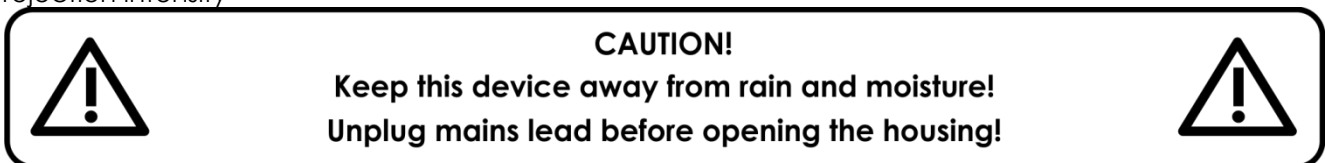

Safety Instructions

Every person involved with the installation, operation and maintenance of this device has to:

- be qualified
- follow the instructions of this manual

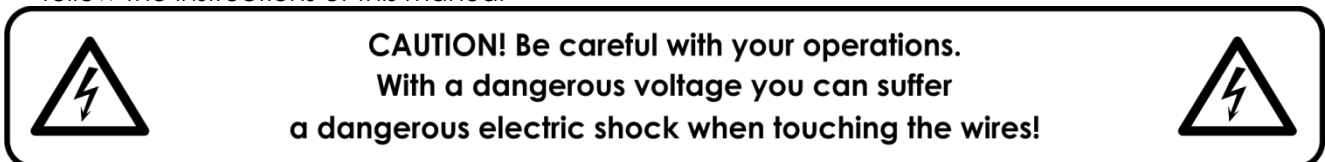

Before your initial start-up, please make sure that there is no damage caused by transportation. Should there be any, consult your dealer and do not use the device.

To maintain perfect condition and to ensure a safe operation, it is absolutely necessary for the user to follow the safety instructions and warning notes written in this manual.

Please consider that damages caused by manual modifications to the device are not subject to warranty.

This device contains no user-serviceable parts. Refer servicing to qualified technicians only.

IMPORTANT:

The manufacturer will not accept liability for any resulting damages caused by the non-observance of this manual or any unauthorized modification to the device.

- Never let the power-cord come into contact with other cables! Handle the power-cord and all connections with the mains with particular caution!
- Never remove warning or informative labels from the unit.
- Never use anything to cover the ground contact.
- Never lift the fixture by holding it at the projector-head, as the mechanics may be damaged. Always hold the fixture at the transport handles.
- Never place any material over the lens.
- Never look directly into the light source.
- Never leave any cables lying around.
- Never unscrew the screws of the rotating gobo, as the ball bearing will otherwise be opened.
- Do not insert objects into air vents.
- Do not connect this device to a dimmerpack.
- Do not switch the device on and off in short intervals, as this would reduce the device's life.
- Do not touch the device's housing bare-handed during its operation (housing becomes very hot). Allow the fixture to cool for at least 5 minutes before handling.
- Do not shake the device. Avoid brute force when installing or operating the device.
- Only use device indoor, avoid contact with water or other liquids.
- Only operate the fixture after having checked that the housing is firmly closed and all screws are tightly fastened.
- Only operate the device after having familiarized with its functions.
- Avoid flames and do not put close to flammable liquids or gases.
- Always keep case closed while operating.
- Always allow free air space of at least 50 cm around the unit for ventilation.
- Always disconnect power from the mains, when device is not used or before cleaning! Only handle the power-cord by the plug. Never pull out the plug by tugging the power-cord.
- Make sure that the device is not exposed to extreme heat, moisture or dust.
- Make sure that the available voltage is not higher than stated on the rear panel.
- Make sure that the power-cord is never crimped or damaged. Check the device and the power-cord from time to time.
- If the lens is obviously damaged, it has to be replaced. So that its functions are not impaired, due to cracks or deep scratches.
- If device is dropped or struck, disconnect mains power supply immediately. Have a qualified engineer inspect for safety before operating.
- If the device has been exposed to drastic temperature fluctuation (e.g. after transportation), do not switch it on immediately. The arising condensation water might damage your device. Leave the device switched off until it has reached room temperature.
- If your Infinity device fails to work properly, discontinue use immediately. Pack the unit securely (preferably in the original packing material), and return it to your Infinity dealer for service.
- For adult use only. Movinghead must be installed out of the reach of children. Never leave the unit running unattended.
- Never attempt to bypass the thermostatic switch or fuses.
- For replacement use fuses of same type and rating only.
- The user is responsible for correct positioning and operating of the Infinity. The manufacturer will not accept liability for damages caused by the misuse or incorrect installation of this device.
- This device falls under protection class I. Therefore it is essential to connect the yellow/green conductor to earth.
- During the initial start-up some smoke or smell may arise. This is a normal process and does not necessarily mean that the device is defective.
- Repairs, servicing and electric connection must be carried out by a qualified technician.
- WARRANTY: Till one year after date of purchase.



CAUTION! Eyedamages!!!
Avoid looking directly into the lightsource!!!
(meant especially for epileptics)!!!



Operating Determinations

- This device is not designed for permanent operation. Consistent operation breaks will ensure that the device will serve you for a long time without defects.
- The minimum distance between light-output and the illuminated surface must be more than 1 meter.
- The maximum ambient temperature $t_a = 45^{\circ}\text{C}$ must never be exceeded.
- The relative humidity must not exceed 50 % with an ambient temperature of 40°C .
- If this device is operated in any other way, than the one described in this manual, the product may suffer damages and the warranty becomes void.
- Any other operation may lead to dangers like short-circuit, burns, electric shock, crash etc.

You endanger your own safety and the safety of others!

Rigging

Please follow the European and national guidelines concerning rigging, trussing and all other safety issues.

Do not attempt the installation yourself !

Always let the installation be carried out by an authorized dealer !

Procedure:

- If the projector is lowered from the ceiling or high joists, professional trussing systems have to be used.
- Use a clamp to mount the projector, with the mounting-bracket, to the trussing system.
- The projector must never be fixed swinging freely in the room.
- The installation must always be secured with a safety attachment, e.g. an appropriate safety net or safety-cable.
- When rigging, derigging or servicing the projector, always make sure, that the area below the installation place is blocked and staying in the area is forbidden.

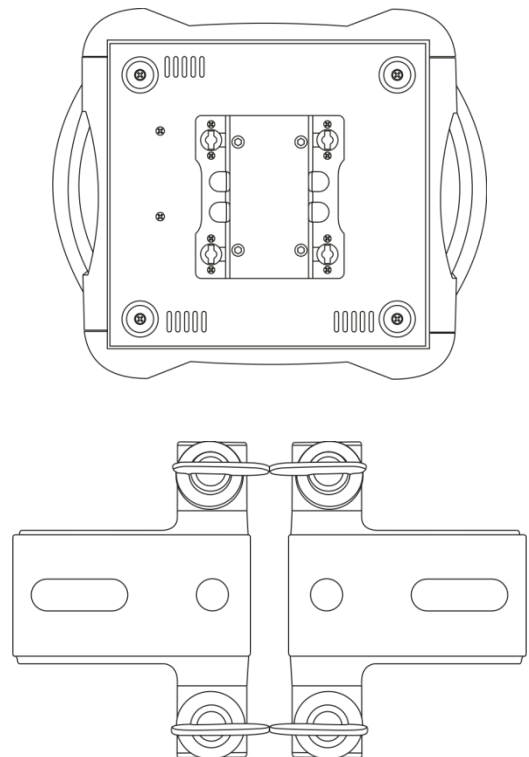
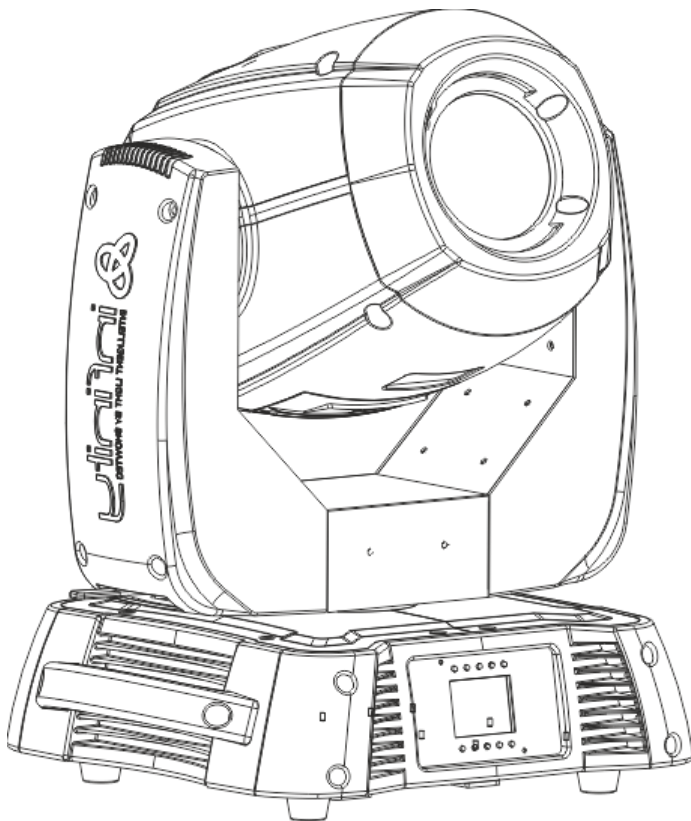

The Infinity can be placed on a flat stage floor or mounted to any kind of truss by a clamp.

Mounting a clamp to the underside of the Infinity moving head

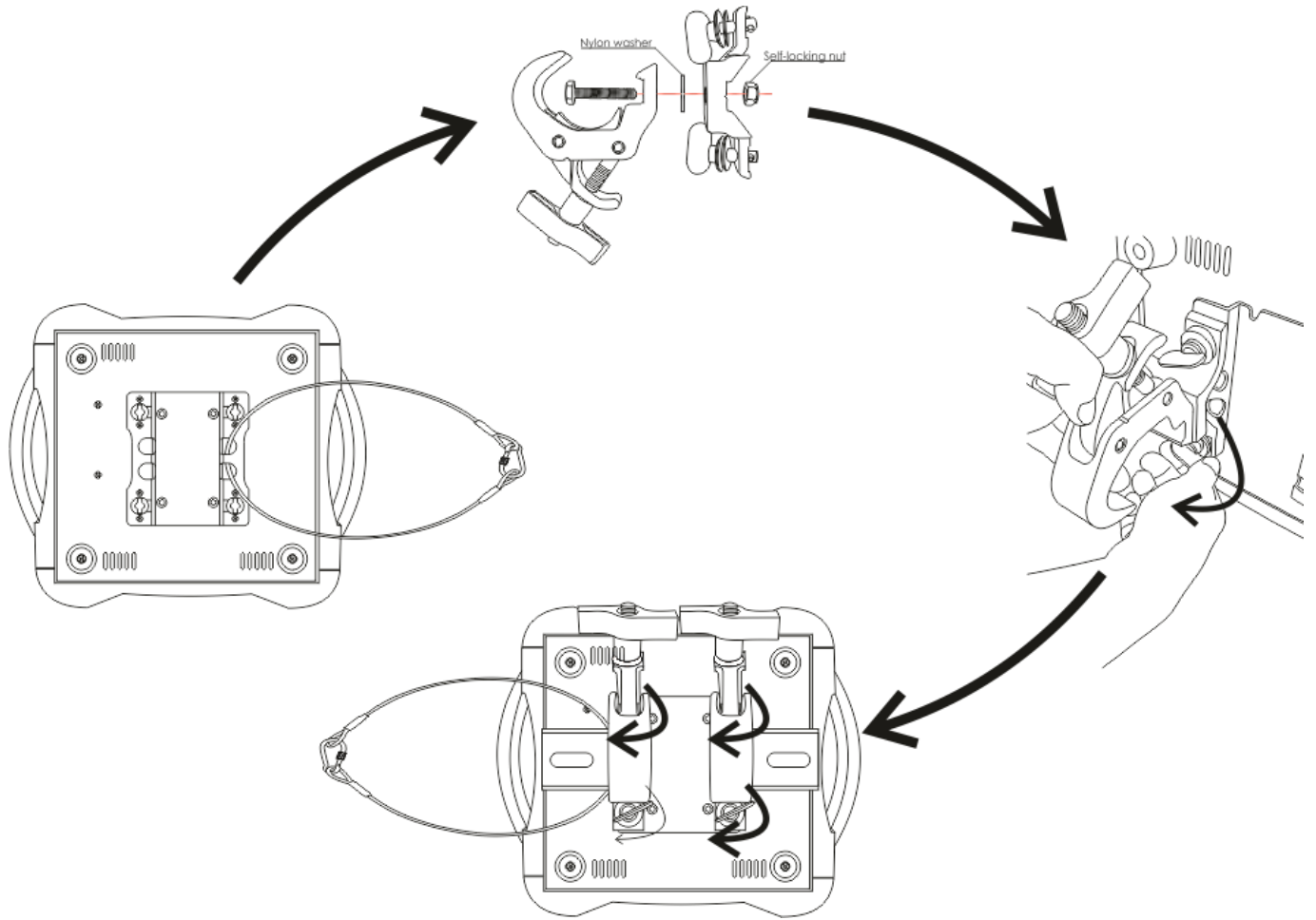

Improper installation can cause serious damage to people and property !

Connection with the mains

Connect the device to the mains with the power-plug.

Always pay attention, that the right color cable is connected to the right place.

International	EU Cable	UK Cable	US Cable	Pin
L	BROWN	RED	YELLOW/COPPER	FASE
N	BLUE	BLACK	SILVER	NULL
	YELLOW/GREEN	GREEN	GREEN	EARTH

Make sure that the device is always connected properly to the earth!

Improper installation can cause serious damage to people and property!

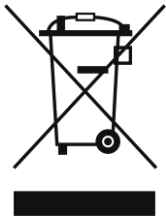

Return Procedure



Returned merchandise must be sent prepaid and in the original packing, call tags will not be issued. Package must be clearly labeled with a Return Authorization Number (RMA number). Products returned without an RMA number will be refused. Highlite will not accept the returned goods or any responsibility. Call Highlite 0031-455667723 or mail offersales@highlite.nl and request an RMA prior to shipping the fixture. Be prepared to provide the model number, serial number and a brief description of the cause for the return. Be sure to properly pack fixture, any shipping damage resulting from inadequate packaging is the customer's responsibility. Highlite reserves the right to use its own discretion to repair or replace product(s). As a suggestion, proper UPS packing or double-boxing is always a safe method to use.

Note: If you are given an RMA number, please include the following information on a piece of paper inside the box:

- 01) Your name
- 02) Your address
- 03) Your phone number
- 04) A brief description of the symptoms

Claims

The client has the obligation to check the delivered goods immediately upon delivery for any shortcomings and/or visible defects, or perform this check after our announcement that the goods are at their disposal. Damage incurred in shipping is the responsibility of the shipper; therefore the damage must be reported to the carrier upon receipt of merchandise.

It is the customer's responsibility to notify and submit claims with the shipper in the event that a fixture is damaged due to shipping. Transportation damage has to be reported to us within one day after receipt of the delivery.

Any return shipment has to be made post-paid at all times. Return shipments must be accompanied with a letter defining the reason for return shipment. Non-prepaid return shipments will be refused, unless otherwise agreed in writing.

Complaints against us must be made known in writing or by fax within 10 working days after receipt of the invoice. After this period complaints will not be handled anymore.

Complaints will only then be considered if the client has so far complied with all parts of the agreement, regardless of the agreement of which the obligation is resulting.

Description of the device

Features

The Infinity iS-200 LED Spot is a moving-head with high output and great effects.

- On-Board: Battery powered full color display including gravity sensor
- It has a rotating 3 facet prism as well a frost filter, which makes it possible to use the fixture also as a true wash light
- Quick lock screws on the covers allow you to change gobos within minutes without the need of any special tools
- LED source the shutter is electronic not mechanical.
- On-Board: 16x2 Character display
- Gobo inner diameter: 23mm, Gobo outer diameter: 27,7mm
- Gobo size: Glass gobo: 27,7 mm (gobo size); 23,4 mm (image diameter); 1 mm (gobo thickness)
Metal gobo: 28,9 mm (gobo size); 25,3 mm (image diameter); 0,5 mm (gobo thickness)
- DMX-control via standard DMX-controller
- User-selectable Pan & Tilt ranges, 540° / 360° / 180°
- Reverse Pan / Tilt movement
- Special: Pan / Tilt movement, Color, Gobo blackout
- Pan 0° -- 540°, Tilt 0° -- 270°
- Pan/Tilt resolution: 16 bit
- Control: DMX-512, Master/Slave, Built-in Programs
- 10 Built in programs selectable by DMX
- Light Source: 200W White LED
- Gobowheel 1: Rotating Gobowheel with 2 glass + 5 metal gobos (Interchangeable)
- Gobowheel 2: Static Gobowheel with 8 metal gobos
- Gobo functions: Gobo-flow effect, Gobo shake
- Colorwheel 1: 7 dichroic-filters and white
- Colorwheel 2: 7 dichroic-filters and white
- Color functions: Split colors, Rainbow-flow effect
- Rotation: Bi-directional
- Prism: 3-facet prism
- Frost filter: Yes
- Output: 78.100 Lux @ 1m.
- Beam Angle: 17°
- Input Voltage: 100-240 VAC
- Continuous Power 370W max. at full output
- Dimmer: 0-100%
- Strobe: 0-20Hz
- Focus: Motorized focus
- Variable motorized Iris (2-100%)
- Housing: Black Metal & Flame-retardant plastic
- Fixture Connection: XLR Data in/out (XLR 3-pin) and XLR Data in/out (XLR 5-pin)
- Neutrik Powercon IN / OUT
- Fuse F7AL / 250V
- Dimensions: 346 x 417 x 551 mm (LxWxH)
- Weight: 21 kg
- User selectable Basic (18CH) or Advanced (21CH) operating modes

Optional accessories

MOD41501 – Wireless DMX upgrade kit



**The Wireless DMX upgrade kit should be installed ONLY by a qualified technician.
Do not attempt installation yourself!**



Overview

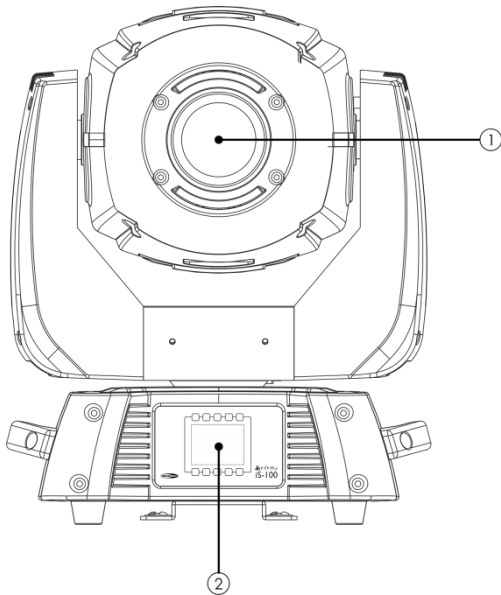

Fig. 01

- 01) Lens
- 02) Menu Buttons + LCD Display

Backside

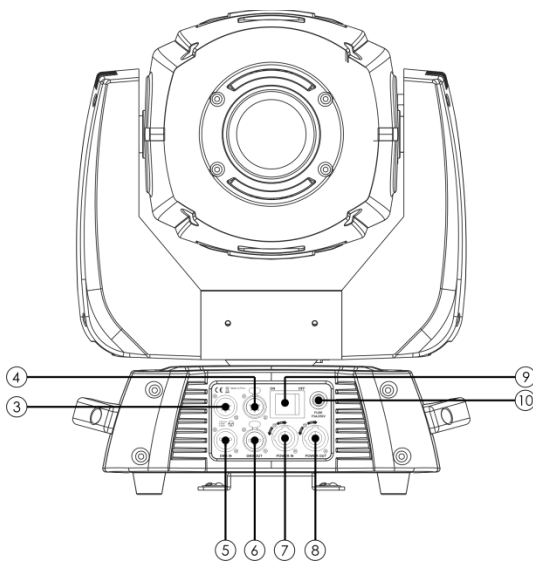

Fig. 02

- 03) DMX signal connector (IN) 5-pin
- 04) DMX signal connector (OUT) 5-pin
- 05) DMX signal connector (IN) 3-pin
- 06) DMX signal connector (OUT) 3-pin
- 07) Neutrik Powercon IN
- 08) Neutrik Powercon OUT
- 09) ON/OFF
- 10) Fuse F7AL 250V

NOTE: Knowledge of DMX is required to fully utilize this unit.

Installation

Remove all packing materials from the Infinity iS-200 LED Spot. Check that all foam and plastic padding is removed. Connect all cables.

Do not supply power before the whole system is set up and connected properly.

Always disconnect from electric mains power supply before cleaning or servicing.

Damages caused by non-observance are not subject to warranty.

Set Up and Operation

Follow the directions below, as they pertain to your preferred operation mode.

Before plugging the unit in, always make sure that the power supply matches the product specification voltage. Do not attempt to operate a 120V specification product on 230V power, or vice versa.

Control Modes

There are 3 modes:

- Stand-alone (built-in programs)
- Master/Slave
- DMX512 (21 Channels ADVANCED or 18 channel BASIC)

One Infinity (Built-in Programs)

- 01) Fasten the effect light onto firm trussing. Leave at least 1 meter on all sides for air circulation.
- 02) Always use a safety cable (ordercode 70140 / 70141).
- 03) Plug the end of the electric mains power cord into a proper electric power supply socket.
- 04) When the Infinity is not connected by a DMX-cable, it functions as a stand-alone device.
- 05) Please see page 16 for more information about the built-in programs.

Multiple Infinity's (Master/Slave control)

- 01) Fasten the effect light onto firm trussing. Leave at least 1 meter on all sides for air circulation.
- 02) Always use a safety cable (ordercode 70140 / 70141).
- 03) Plug the end of the electric mains power cord into a proper electric power supply socket.
- 04) Use a 3-p XLR cable to connect the Infinity.

The pins:



1. Earth
2. Signal (-)
3. Signal (+)

- 05) Link the units as shown in (Fig. 3), Connect a DMX signal cable from the first unit's DMX "out" socket to the second unit's "in" socket. Repeat this process to link the second, third, and fourth units. You can use the same functions on the master device as described on page 15 (Built-in Programs or Music control)). This means on the master device you can set your desired operation Mode and all slave devices will react the same as the master device.

Multiple Infinity's (Master/Slave control)

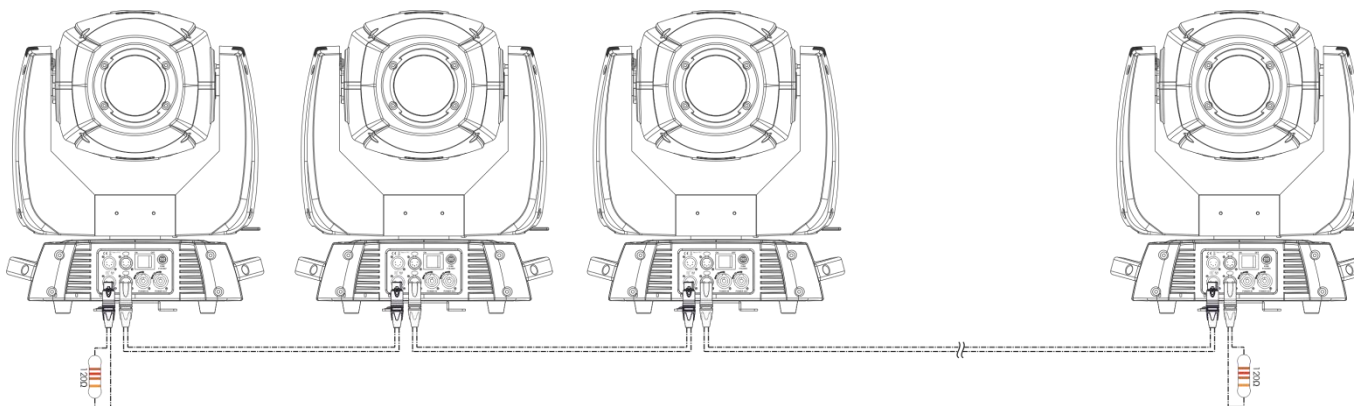
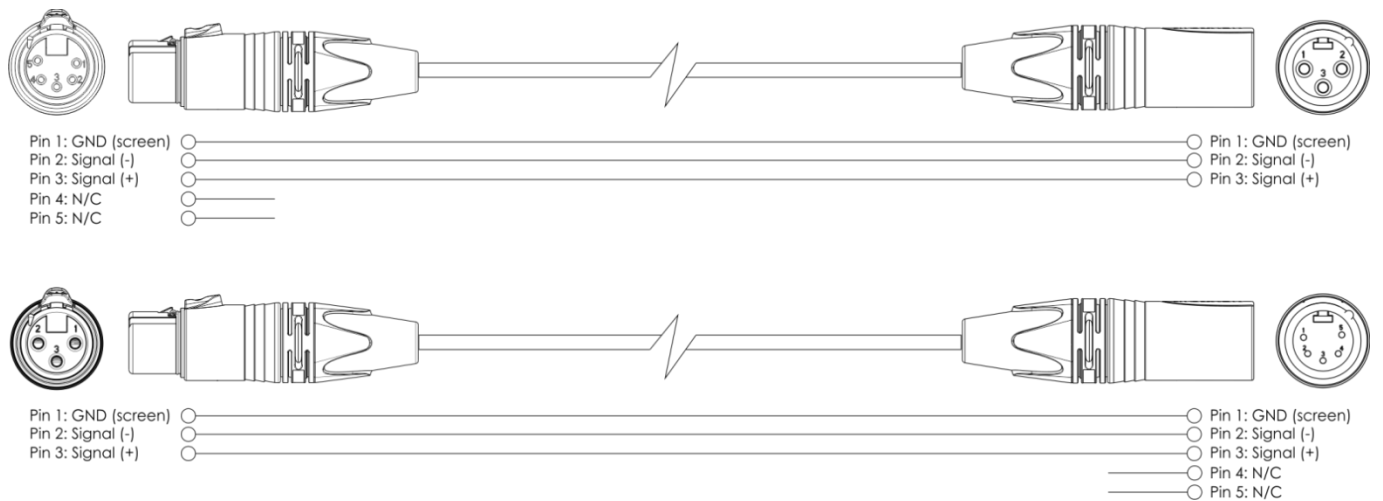

Fig. 03

Multiple Infinity's (DMX Control)

- 01) Fasten the effect light onto firm trussing. Leave at least 1 meter on all sides for air circulation.
- 02) Always use a safety cable (ordercode 70140 / 70141).
- 03) Plug the end of the electric mains power cord into a proper electric power supply socket.
- 04) Use a a 3-p XLR cable to connect the Infinity's and other devices.



- 05) Link the units as shown in (figure 4), Connect a DMX signal cable from the first unit's DMX "out" socket to the second unit's "in" socket. Repeat this process to link the second, third, and fourth units.
- 06) Supply electric power: Plug electric mains power cords into each unit's IEC socket, then plug the other end of the mains power cord into proper electric power supply sockets, starting with the first unit. Do not supply power before the whole system is set up and connected properly.

Multiple Infinity's DMX Set Up

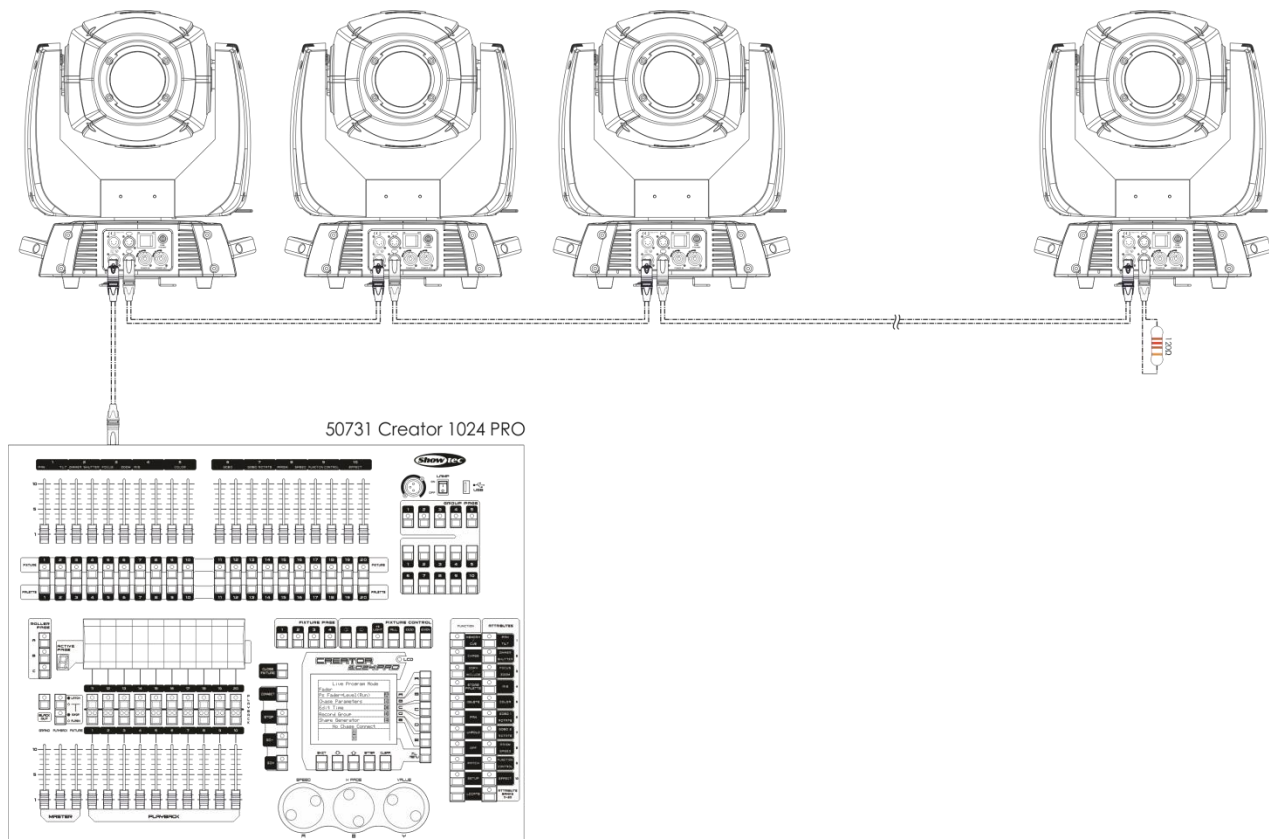

Fig. 04

Note : Link all cables before connecting electric power

Fixture Linking

You will need a serial data link to run light shows of one or more fixtures using a DMX-512 controller or to run synchronized shows on two or more fixtures set to a master/slave operating mode. The combined number of channels required by all the fixtures on a serial data link determines the number of fixtures the data link can support.

Important: Fixtures on a serial data link must be daisy chained in one single line. To comply with the EIA-485 standard no more than 30 devices should be connected on one data link. Connecting more than 30 fixtures on one serial data link without the use of a DMX optically isolated splitter may result in deterioration of the digital DMX signal.



Maximum recommended DMX data link distance: 100 meters

Maximum recommended number of Infinity's on a DMX data link: 30 fixtures

Data Cabling

To link fixtures together you must obtain data cables. You can purchase DAP Audio certified DMX cables directly from a dealer/distributor or construct your own cable. If you choose to create your own cable please use data-grade cables that can carry a high quality signal and are less prone to electromagnetic interference.

DAP Audio DMX Data Cables

- DAP Audio Basic microphone cable for allround use. bal. XLR/M 3-pin > XLR/F 3-pin. **Ordercode** FL01150 (1,5 m), FL013 (3 m), FL016 (6 m), FL0110 (10 m), FL0115 (15 m), FL0120 (20 m).
- DAP Audio X-type data cable XLR/M 3-pin > XLR/F 3-pin. **Ordercode** FLX0175 (0,75 m), FLX01150 (1,5 m), FLX013 (3 m), FLX016 (6 m), FLX0110 (10 m).
- DAP Audio cable for the demanding user with exceptional audio-qualities and connector made by Neutrik®. **Ordercode** FL71150 (1,5 m), FL713 (3 m), FL716 (6 m), FL7110 (10 m).
- DAP Audio cable for the demanding user with exceptional audio-qualities and connector made by Neutrik®. **Ordercode** FL7275 (0,75 m), FL72150 (1,5 m), FL723 (3 m), FL726 (6 m), FL7210 (10 m).
- DAP Audio 110 Ohm cable with digital signal transmission. **Ordercode** FL0975 (0,75 m), FL09150 (1,5 m), FL093 (3 m), FL096 (6 m), FL0910 (10 m), FL0915 (15 m), FL0920 (20 m).

The Infinity iS-200 LED Spot can be operated with a controller in **control mode** or without the controller in **stand-alone mode**.

Control Panel

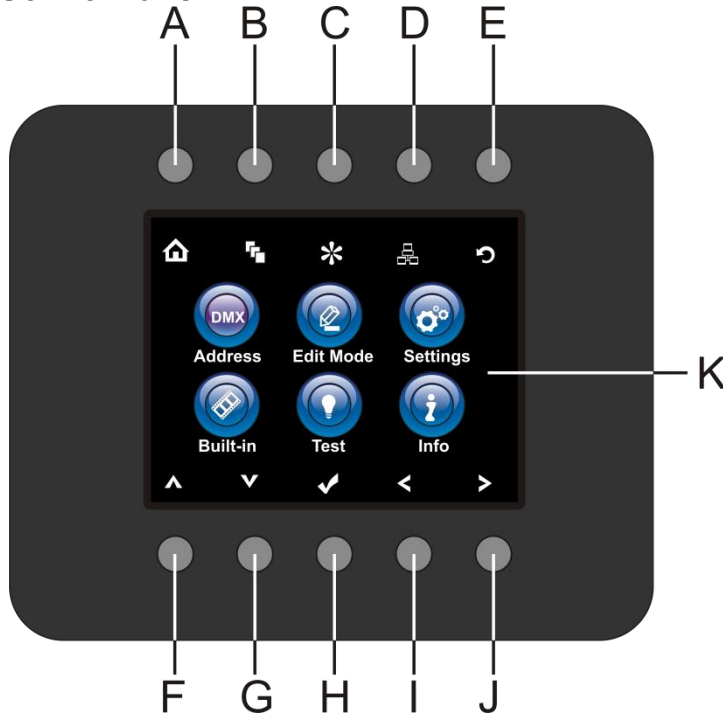

- A) Home button
- B) Edit Menu button
- C) Settings Mode Button
- D) Address Setting Button
- E) Infinity Logo Button
- F) Up Button
- G) Down Button
- H) OK/ENTER
- I) Left Button
- J) Right Button
- K) LCD Display

Fig. 05

Control Mode

The fixtures are individually addressed on a data-link and connected to the controller. The fixtures respond to the DMX signal from the controller. (When you select the DMX address and save it, the controller will display the saved DMX address the next time.)

DMX Addressing

The control panel on the front side of the base allows you to assign the DMX fixture address, which is the first channel from which the Infinity will respond to the controller. Please note when you use the controller, the unit has **21** channels. When using multiple Infinity's, make sure you set the DMX addresses right. Therefore, the DMX address of the first Infinity's should be **1(001)**; the DMX address of the second Infinity should be **1+21=22 (022)**; the DMX address of the third Infinity should be **22+21=43 (043)**, etc. Please, be sure that you don't have any overlapping channels in order to control each Infinity correctly. If two or more Infinity's are addressed similarly, they will work similarly. For address settings, please refer to the instructions under "Addressing".

Controlling:







After having addressed all Infinity fixtures, you may now start operating these via your lighting controller. **Note:** After switching on, the Infinity will automatically detect whether DMX 512 data is received or not. If there is no data received at the DMX-input, the "LED" on the control panel will not flash. The problem may be:
 The XLR cable from the controller is not connected with the input of the Infinity.
 The controller is switched off or defective, the cable or connector is defective, or the signal wires are swapped in the input connector.







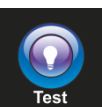



Note: It's necessary to insert a XLR termination plug (with 120 Ohm) in the last fixture in order to ensure proper transmission on the DMX data link.

Menu Overview





Main Menu Options

-  DMX address
-  Edit Mode
-  Settings Menu
-  Built-in Programs
-  Test Mode
-  Info

-  Home
-  Up
-  Edit Menu
-  Down
-  Setting Mode
-  OK
-  Address Setting
-  Left
-  Infinity Logo
-  Right

1. DMX Addressing

With this menu you can set the DMX address.

01) Press the  button and select .

02) Press the  button, to confirm. You can choose 512 different DMX addresses.
Use the Left /Right / Up / Down buttons to select the required address from **001** ^{Up/Down} **512**.

03) Once you have set the desired DMX address, press the  button to store your DMX address.



2. Edit Mode

With this menu you can set your desired mode.

01) Press the  button and select  Edit Mode.

02) Press the  button, to confirm. You can choose 3 different modes. Use the Up / Down buttons to select the required mode:

DMX MODE 18(CH)	YES
DMX MODE 21(CH)	NO
MASTER MODE	NO

03) Once you have selected the desired mode, press the   buttons to change the value from No to YES.

04) Once you have selected the desired setting, press the  button to store your settings.

05) If the device has been set to master, all slave devices will follow the master movement.

06) If the device has been set to slave, it will react the same as its master device.

3. Settings Menu

With this menu you can set your desired mode.



01) Press the  button and select  Settings.

02) Press the  button, to confirm. You can choose 11 different modes. Use the Up / Down buttons to select the required mode:

Pan Reserve	YES
Tilt Reserve	NO
Screen Reverse	NO
Auto Screen. Re	NO
Pan Angle	540
Tilt Angle	270
BL.0.P/T Move	NO
BL.0.Color Move	NO
BL.0.Gobo Move	NO
Reset Function	
Factory Settings	NO



Reset Function	
Pan/Tilt	YES
Prism	NO
Color/Frost	NO
Gobo&R/Gobo2	NO
Focus/Iris	NO
All	NO

03) Once you have selected the desired mode, press the   buttons to change the value from No to YES.

04) If you press the OK button at the Reset function, a new Menu will open.

05) You can set 6 different reset options.

06) Once you have selected the desired setting, press the  button to store your settings.



4. Built-in Programs

With this menu you can set your desired mode.

01) Press the  button and select .

02) Press the  button, to confirm. You can choose 10 different modes. Use the Up / Down buttons to select the required mode:



Program Number 0	YES
Program Number 1	NO
Program Number 2	NO
Program Number 3	NO
Program Number 4	NO
Program Number 5	NO
Program Number 6	NO
Program Number 7	NO
Program Number 8	NO
Program Number 9	NO

03) Once you have selected the desired mode, press the   buttons to change the value from No to YES.



04) Once you have selected the desired setting, press the  button to store your settings.

5. Test Menu

With this menu you can set your desired mode.

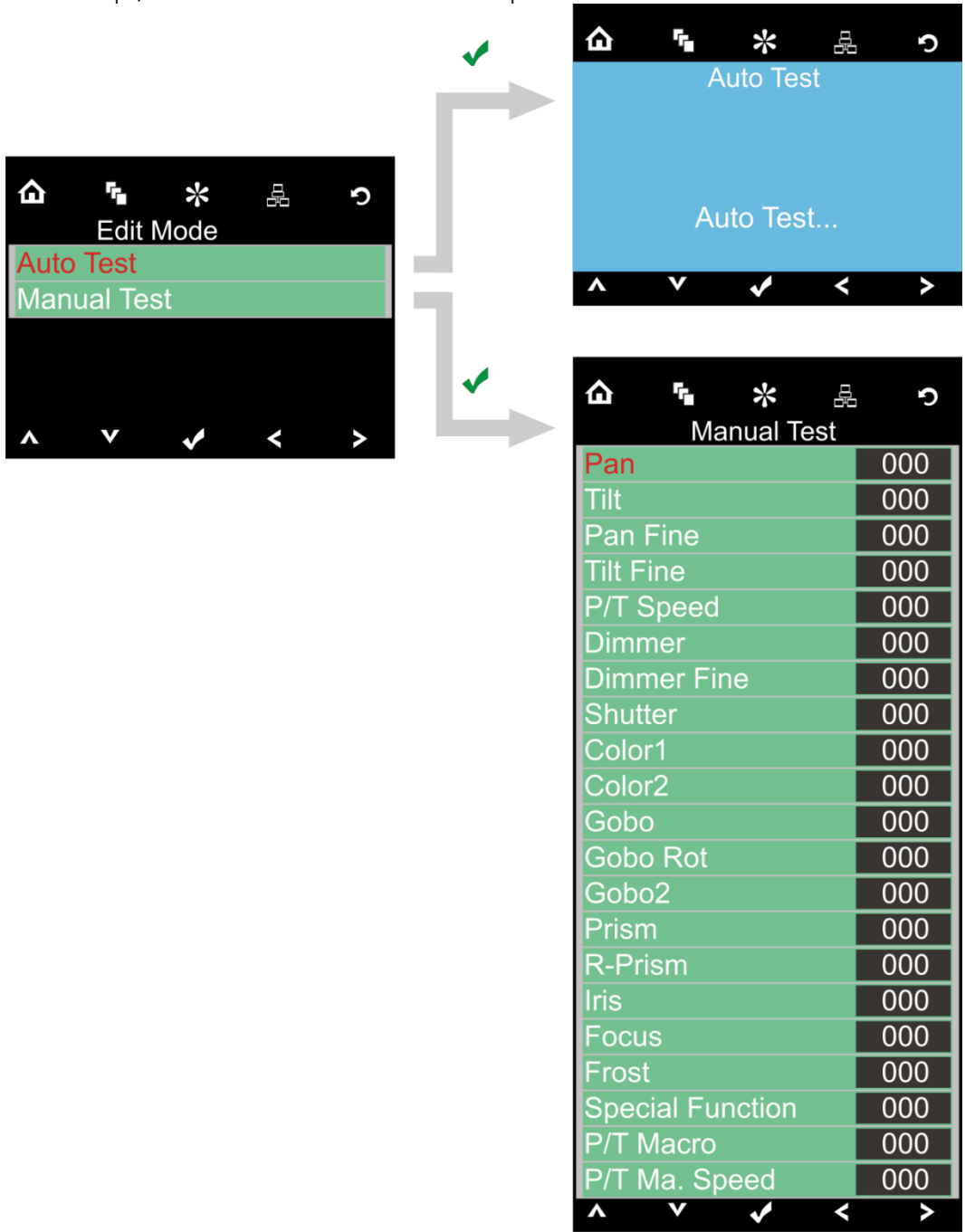
- 01) Press the  button and select .
- 02) Press the  button, to confirm. You can choose 2 different modes.
Use the Up / Down buttons to select the required mode:



- 03) Once you have selected the desired mode, press the   buttons to change the value from No to YES.
- 04) If you press the OK button at the Reset function, a new Menu will open.
- 05) You can set 21 different Test options.
- 06) Once you have selected the desired setting, press the  button to store your settings.

6. Information Menu

With this menu you can set your desired mode.

01) Press the  button and select .

02) Press the  button, to confirm.

03) You can only view 4 current settings, you cannot change anything



DMX Channels

21 Channels (Advanced)

Channel 1 – Horizontal movement (Pan)

Push the slider up, in order to move head horizontally (PAN).
 Gradual head adjustment from one end of the slider to the other (0-255, 128-center).
 The head can be turned by 540° and stopped at any position you wish.

Channel 2 – Vertical movement (Tilt)

Push the slider, up in order to move head vertically (TILT).
 Gradual head adjustment from one end of the slider to the other (0-255, 128-center).
 The head can be turned by 270° and stopped at any position you wish.

Channel 3 – Pan fine 16 bit

Channel 4 – Tilt fine 16 bit

Channel 5 – PAN/TILT Speed

0-255 From Max Speed (0) to Min. Speed (255)

Channel 6 – Dimmer intensity (Shutter must be open)

0-255 From black to brightest

Channel 7 – Dimmer Fine (Shutter must be open)

0-255 From black to brightest

Channel 8 – Shutter / Strobe (Dimmer must be open)

0-3	Close
4-7	Shutter open
8-76	Strobe effect, from slow to fast (0-10 flashes/sec.)
77-145	Pulse Strobe effect, from slow to fast (0-10 flashes/sec.)
146-215	Random Shutter
216-255	Shutter open

Channel 9 – Color Wheel 1

Linear color change following the movement of the slider. Between 128 - 255, the color wheel rotates continuously the so-called "Rainbow" effect.

0-7	Open / White
8-15	Light Yellow
16-23	Light Blue
24-31	Light Green
32-39	High Transparent Red
40-47	Rose-Red
48-55	Blue
56-63	Pink
64-71	Split Color White / Light Yellow
72-79	Split Color Light Yellow / Light Blue
80-87	Split Color Light Blue / Light Green
88-95	Split Color Light Green / M High Transparent Red
96-103	Split Color High Transparent Red / Rose-Red
104-111	Split Color Rose-Red / Blue
112-119	Split Color Blue / Pink
120-127	Split Color Pink / White
128-191	Clockwise rotation (CW) rainbow effect from slow to fast
192-255	Counter-clockwise rotation (CCW) rainbow effect from slow to fast

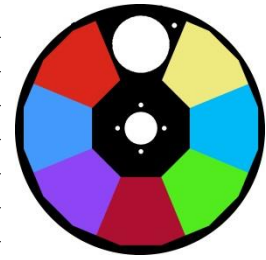

Channel 10 – Color Wheel 2

Linear color change following the movement of the slider. Between 128 - 255, the color wheel rotates continuously the so-called "Rainbow" effect.

0-7	Open / White
8-15	Cool Color 1
16-23	Cool Color 2r
24-31	Green
32-39	UV
40-47	Orange
48-55	Pink-Purple
56-63	Bright Blue
64-71	Split Color White / Cool Color 1
72-79	Split Color Cool Color 1 / Cool Color 2r
80-87	Split Color Cool Color 2r / Green
88-95	Split Color Green / UV
96-103	Split Color UV / Orange
104-111	Split Color Orange / Pink-Purple
112-119	Split Color Pink-Purple / Bright Blue
120-127	Split Color Bright Blue / White
128-191	Clockwise rotation (CW) rainbow effect from slow to fast
192-255	Counter-clockwise rotation (CCW) rainbow effect from slow to fast

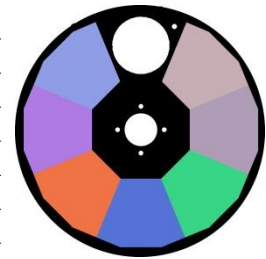

Channel 11 – Rotating Gobo-wheel + Gobo Shake

0-7	Open / White
8-15	Gobo 1 (Glass)
16-23	Gobo 2 (Glass)
24-31	Gobo 3 (Metal)
32-39	Gobo 4 (Metal)
40-47	Gobo 5 (Metal)
48-55	Gobo 6 (Metal)
56-63	Gobo 7 (Glass)
64-71	Gobo Shake 7 from slow to fast
72-79	Gobo Shake 6 from slow to fast
80-87	Gobo Shake 5 from slow to fast
88-95	Gobo Shake 4 from slow to fast
96-103	Gobo Shake 3 from slow to fast
104-111	Gobo Shake 2 from slow to fast
112-119	Gobo Shake 1 from slow to fast
120-127	Open / White
128-191	Clockwise rotation (CW) rainbow effect from slow to fast
192-255	Counter-clockwise rotation (CCW) rainbow effect from slow to fast



Channel 12 – Gobo rotation

0-63	Gobo-indexing
64-147	Clockwise rotation (CW) from slow to fast
148-231	Counter-clockwise rotation (CCW) from slow to fast
232-255	Gobo bouncing

Channel 13 – Static Gobo-wheel + Gobo Shake

0-6	Open / White
7-13	Gobo 1
14-20	Gobo 2
21-27	Gobo 3
28-34	Gobo 4
35-41	Gobo 5
42-48	Gobo 6
49-55	Gobo 7
56-63	Gobo 8
64-71	Gobo Shake 8 from slow to fast
72-78	Gobo Shake 7 from slow to fast
79-85	Gobo Shake 6 from slow to fast
86-92	Gobo Shake 5 from slow to fast
93-99	Gobo Shake 4 from slow to fast
100-106	Gobo Shake 3 from slow to fast
107-113	Gobo Shake 2 from slow to fast
114-120	Gobo Shake 1 from slow to fast
121-127	Open
128-191	Clockwise rotation (CW) rainbow effect from slow to fast
192-255	Counter-clockwise rotation (CCW) rainbow effect from slow to fast



Channel 14 – Prism

0-4	Open
5-255	3-facet Prism Effect,

Channel 15 – Prism rotation

0-127	Prism-indexing
128-189	Clockwise rotation (CW) from slow to fast
190-193	Stop
194-255	Counter-clockwise rotation (CCW) from slow to fast

Channel 16 – Iris

0-63	Iris from big to small
64-127	Auto Zoom from slow to fast
128-191	Zoom in slowly, zoom out fast
192-255	Zoom in fast, zoom out slowly

Channel 17 – Focus

0-255	Continuous adjustment from far to near
-------	--

Channel 18 – Frost Effect

0-255	Frost Effect
-------	--------------

Channel 19 – Channel Functions

0-7	No Function
8-14	Blackout during Pan/Tilt movement
15-23	Blackout during Colorwheel movement
24-31	Blackout during Gobowheel movement
32-39	Blackout during Pan/Tilt/Colorwheel movement
40-47	Blackout during Pan/Tilt/Gobowheel movement
48-55	Blackout during Pan/Tilt/Gobowheel /Colorwheel movement
56-87	No Function
88-95	No Function
96-103	Reset Pan after 3 seconds
104-111	Reset Tilt after 3 seconds
112-119	Reset Colorwheel after 3 seconds
120-127	Reset Gobowheel after 3 seconds
128-135	Reset Gobo rotation after 3 seconds
136-143	Reset Prism after 3 seconds (Tip: nice fade out prism effect)
144-151	Reset Focus after 3 seconds
152-159	Reset All channels after 3 seconds
160-167	Reset Iris
168-175	Reset Frost Effect
176-239	No Function
240-247	XY Smoothing model open
248-255	XY Smoothing model to shut down

Channel 20 – Built-in Programs

0-7	No Function
8-15	Built-in Program 1
16-23	Built-in Program 2
24-31	Built-in Program 3
32-39	Built-in Program 4
40-47	Built-in Program 5
48-55	Built-in Program 6
56-63	Built-in Program 7
64-71	Built-in Program 8
72-79	Built-in Program 9
80-87	Built-in Program 10
88-95	Built-in Program 11
96-103	Built-in Program 12
104-111	Built-in Program 13
112-119	Built-in Program 14
120-127	Built-in Program 15
128-135	Built-in Program 16
136-143	Built-in Program 17
144-151	Built-in Program 18
152-159	Built-in Program 19
160-167	Built-in Program 20
168-175	Built-in Program 21
176-183	Built-in Program 22
184-191	Built-in Program 23
192-199	Built-in Program 24
200-207	Built-in Program 25
208-215	Built-in Program 26
216-223	Built-in Program 27
224-231	Built-in Program 28
232-239	Built-in Program 29
240-247	Built-in Program 30
248-255	Built-in Program 31

Channel 21 – Program Speed

0-255 From fast to slow

18 Channels (Basic)

Channel 1 – Horizontal movement (Pan)

Push the slider up, in order to move head horizontally (PAN).
 Gradual head adjustment from one end of the slider to the other (0-255, 128-center).
 The head can be turned by 540° and stopped at any position you wish.

Channel 2 – Vertical movement (Tilt)

Push the slider, up in order to move head vertically (TILT).
 Gradual head adjustment from one end of the slider to the other (0-255, 128-center).
 The head can be turned by 270° and stopped at any position you wish.

Channel 3 – Pan fine 16 bit

Channel 4 – Tilt fine 16 bit

Channel 5 – PAN/TILT Speed

0-255 From Max Speed (0) to Min. Speed (255)

Channel 6 – Dimmer intensity (Shutter must be open )

0-255 From black to brightest

Channel 7 – Dimmer Fine (Shutter must be open )

0-3	Close
4-7	Shutter open
8-76	Strobe effect, from slow to fast (0-10 flashes/sec.)
77-145	Pulse Strobe effect, from slow to fast (0-10 flashes/sec.)
146-215	Random Shutter
216-255	Shutter open

Channel 8 – Color Wheel 1

Linear color change following the movement of the slider. Between 128 - 255, the color wheel rotates continuously the so-called "Rainbow" effect.

0-7	Open / White
8-15	Light Yellow
16-23	Light Blue
24-31	Light Green
32-39	High Transparent Red
40-47	Rose-Red
48-55	Blue
56-63	Pink
64-71	Split Color White / Light Yellow
72-79	Split Color Light Yellow / Light Blue
80-87	Split Color Light Blue / Light Green
88-95	Split Color Light Green / M High Transparent Red
96-103	Split Color High Transparent Red / Rose-Red
104-111	Split Color Rose-Red / Blue
112-119	Split Color Blue / Pink
120-127	Split Color Pink / White
128-191	Clockwise rotation (CW) rainbow effect from slow to fast
192-255	Counter-clockwise rotation (CCW) rainbow effect from slow to fast

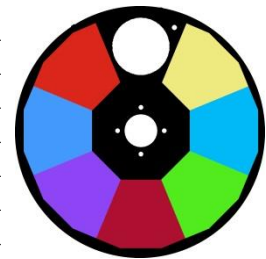

Channel 9 – Color Wheel 2

Linear color change following the movement of the slider. Between 128 - 255, the color wheel rotates continuously the so-called "Rainbow" effect.

0-7	Open / White
8-15	Cool Color 1
16-23	Cool Color 2r
24-31	Green
32-39	UV
40-47	Orange
48-55	Pink-Purple
56-63	Bright Blue
64-71	Split Color White / Cool Color 1
72-79	Split Color Cool Color 1 / Cool Color 2r
80-87	Split Color Cool Color 2r / Green
88-95	Split Color Green / UV
96-103	Split Color UV / Orange
104-111	Split Color Orange / Pink-Purple
112-119	Split Color Pink-Purple / Bright Blue
120-127	Split Color Bright Blue / White
128-191	Clockwise rotation (CW) rainbow effect from slow to fast
192-255	Counter-clockwise rotation (CCW) rainbow effect from slow to fast

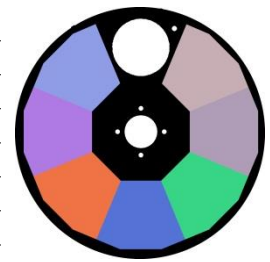

Channel 10 – Rotating Gobo-wheel + Gobo Shake

0-7	Open / White
8-15	Gobo 1 (Glass)
16-23	Gobo 2 (Glass)
24-31	Gobo 3 (Metal)
32-39	Gobo 4 (Metal)
40-47	Gobo 5 (Metal)
48-55	Gobo 6 (Metal)
56-63	Gobo 7 (Glass)
64-71	Gobo Shake 7 from slow to fast
72-79	Gobo Shake 6 from slow to fast
80-87	Gobo Shake 5 from slow to fast
88-95	Gobo Shake 4 from slow to fast
96-103	Gobo Shake 3 from slow to fast
104-111	Gobo Shake 2 from slow to fast
112-119	Gobo Shake 1 from slow to fast
120-127	Open / White
128-191	Clockwise rotation (CW) rainbow effect from slow to fast
192-255	Counter-clockwise rotation (CCW) rainbow effect from slow to fast



Channel 11 – Gobo rotation

0-63	Gobo-indexing
64-147	Clockwise rotation (CW) from slow to fast
148-231	Counter-clockwise rotation (CCW) from slow to fast
232-255	Gobo bouncing

Channel 12 – Static Gobo-wheel + Gobo Shake

0-6	Open / White
7-13	Gobo 1
14-20	Gobo 2
21-27	Gobo 3
28-34	Gobo 4
35-41	Gobo 5
42-48	Gobo 6
49-55	Gobo 7
56-63	Gobo 8
64-71	Gobo Shake 8 from slow to fast
72-78	Gobo Shake 7 from slow to fast
79-85	Gobo Shake 6 from slow to fast
86-92	Gobo Shake 5 from slow to fast
93-99	Gobo Shake 4 from slow to fast
100-106	Gobo Shake 3 from slow to fast
107-113	Gobo Shake 2 from slow to fast
114-120	Gobo Shake 1 from slow to fast
121-127	Open
128-191	Clockwise rotation (CW) rainbow effect from slow to fast
192-255	Counter-clockwise rotation (CCW) rainbow effect from slow to fast

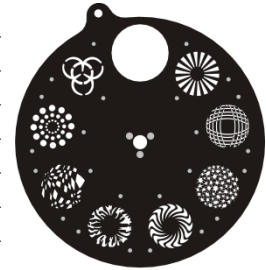

Channel 13 – Prism

0-4	Open
5-255	3-facet Prism Effect,

Channel 14 – Prism rotation

0-127	Prism-indexing
128-189	Clockwise rotation (CW) from slow to fast
190-193	Stop
194-255	Counter-clockwise rotation (CCW) from slow to fast

Channel 15– Iris

0-63	Iris from big to small
64-127	Auto Zoom from slow to fast
128-191	Zoom in slowly, zoom out fast
192-255	Zoom in fast, zoom out slowly

Channel 16 – Focus

0-255	Continuous adjustment from far to near
-------	--

Channel 17 – Frost Effect

0-255	Frost Effect
-------	--------------

Channel 18 – Channel Functions

0-7	No Function
8-14	Blackout during Pan/Tilt movement
15-23	Blackout during Colorwheel movement
24-31	Blackout during Gobowheel movement
32-39	Blackout during Pan/Tilt/Colorwheel movement
40-47	Blackout during Pan/Tilt/Gobowheel movement
48-55	Blackout during Pan/Tilt/Gobowheel /Colorwheel movement
56-87	No Function
88-95	No Function
96-103	Reset Pan after 3 seconds
104-111	Reset Tilt after 3 seconds
112-119	Reset Colorwheel after 3 seconds
120-127	Reset Gobowheel after 3 seconds
128-135	Reset Gobo rotation after 3 seconds
136-143	Reset Prism after 3 seconds (Tip: nice fade out prism effect)
144-151	Reset Focus after 3 seconds
152-159	Reset All channels after 3 seconds
160-167	Reset Iris
168-175	Reset Frost Effect
176-239	No Function
240-247	XY Smoothing model open
248-255	XY Smoothing model to shut down

Channel settings

41501 Infinity IS-200 Fixture-settings																					
Channel	1	2	3	4	5	6	7	8	9	10	11	12	13	14	15	16	17	18	19	20	21
Function	Pan	Tilt	Pan-Fine	Tilt-Fine	Pan/Tilt Speed	Dimmer	Dimmer 16-bit	Shutter Strobe	Colorwheel 1	Colorwheel 2	Rotating Gobowheel	Gobo Rotation	Static Gobowheel	Prism	Prism Rotation	Iris	Focus	Frost	Functions	Built-in Programs	Progr Speed
255	255	255	255	255	255	255	255	255	100-255	100-255	100-255	255	100-255	255	255	255	255	255	248-255	248-255	255
128									100-255	100-255	100-255	255	100-255	255	255	255	255	255	248-255	248-255	255
0									100-255	100-255	100-255	255	100-255	255	255	255	255	255	248-255	248-255	255

Fig. 06

Maintenance

The Infinity iS-200 LED Spot requires almost no maintenance. However, you should keep the unit clean. Otherwise, the fixture's light-output will be significantly reduced. Disconnect the mains power supply and then wipe the cover with a damp cloth. Wipe the front glass panel clean with glass cleaner and a soft cloth. Do not use alcohol or solvents. The front glass panel will require weekly cleaning, as smoke-fluid tends to build up residues, reducing the light-output very quickly. Do not immerse in liquid.

The cooling-fans, colour-wheel, the gobowheel, the gobos and the internal lenses should be cleaned monthly with a soft brush.

Please clean internal components once a year with a light brush and vacuum cleaner.

Keep connections clean. Disconnect electric power, and then wipe the DMX and audio connections with a damp cloth. Make sure connections are thoroughly dry before linking equipment or supplying electric power.

The operator has to make sure that safety-relating and machine-technical installations are to be inspected by an expert after every year in the course of an acceptance test.

The operator has to make sure that safety-relating and machine-technical installations are to be inspected by a skilled person once a year.

The following points have to be considered during the inspection:

- 01) All screws used for installing the device or parts of the device have to be tightly connected and must not be corroded.
- 02) There may not be any deformations on housings, fixations and installation spots.
- 03) Mechanically moving parts like axles, eyes and others may not show any traces of wearing.
- 04) The electric power supply cables must not show any damages or material fatigue.

Replacing a Fuse

Power surges, short-circuit or inappropriate electrical power supply may cause a fuse to burn out. If the fuse burns out, the product will not function whatsoever. If this happens, follow the directions below to do so.

- 01) Unplug the unit from electric power source.
- 02) Insert a screwdriver into the slot in the fuse cover. Turn the screwdriver to the left, at the same time gently push a bit (Turn and Push). The fuse will come out.
- 03) Remove the used fuse. If brown or unclear, it is burned out.
- 04) Insert the replacement fuse into the holder where the old fuse was. Reinsert the fuse cover. Be sure to use a fuse of the same type and specification. See the product specification label for details

Replacing a Gobo from the rotating Gobowheel

- 01) Disconnect mains power supply and set the switch to OFF.
- 02) Make sure that the gobo you want to insert has the same size. For the right size, see below.

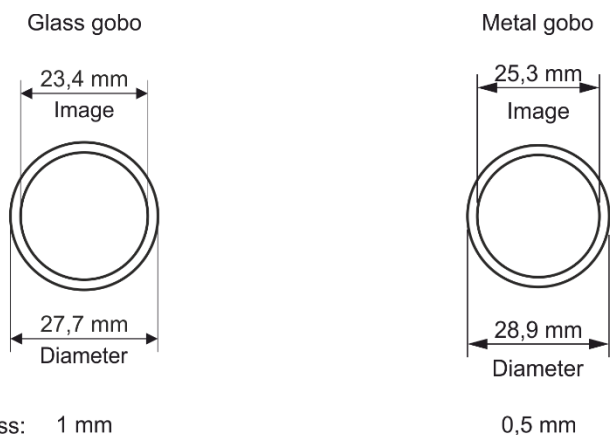

Fig. 07

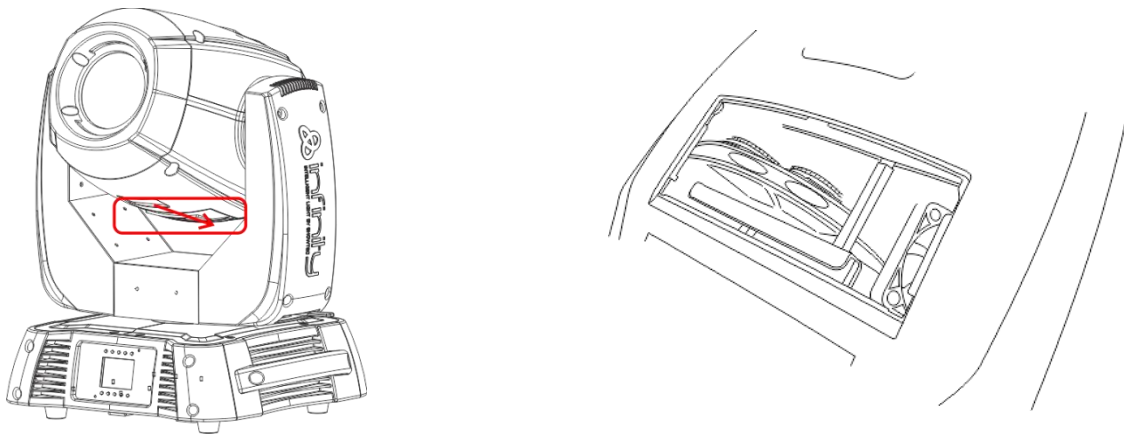

Fig. 08

- 03) Loosen the service lid of the housing, by sliding it to the bottom.
- 04) Gently tilt the head so the small metal housing will slide out more easy.
- 05) Turn the gobo wheel, with the gobo you want to remove, to the upside.
- 06) Gently lift up the gobo holder 10° and then gently pull out the gobo from its position.

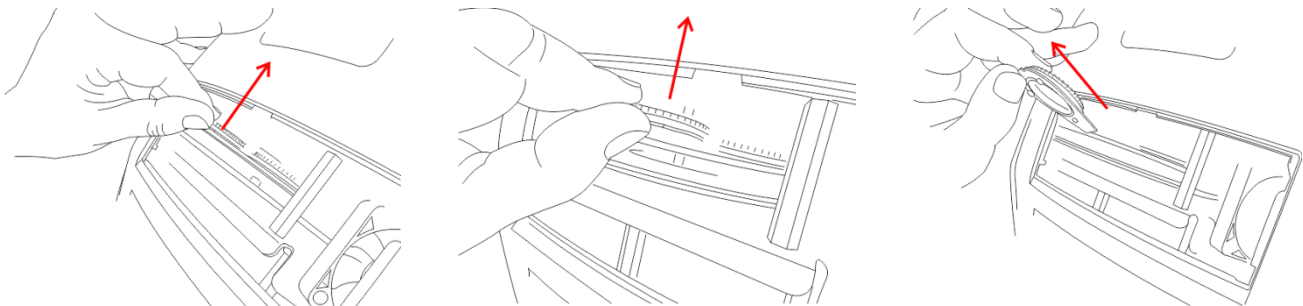
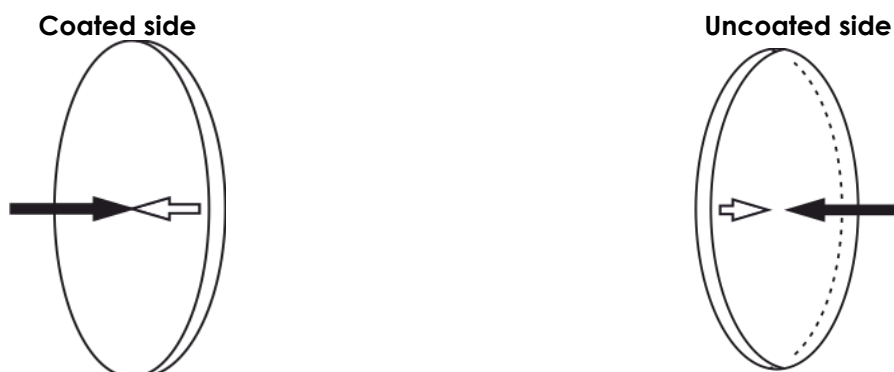

Fig. 09

- 07) Very carefully take the gobo out of the gobo holder with a pair of pliers.
- 08) Place the new gobo in the gobo holder. Carefully put the pinchcock back, gently press the pinchcock a little bit together. Possibly use a pair of pliers to press the pinchcock a little bit together.
- 09) Put the gobo holder back under the pressing snap and push it back.
- 10) Replace the maintenance caps and fasten all screws.

Glass Gobo Orientation

Coated glass gobos are inserted with the coating against the rim of the holder (away from the spring). Textured gobos are inserted with the smooth side against the spring. This provides the best results when combining rotating gobos.



When an object is held up to the coated side there is no space between the object and its reflection. The back edge of the gobo cannot be seen when looking through the coated side.

When an object is held up to the uncoated side there is a space between the object and its reflection. The back edge of the gobo can be seen when looking through the uncoated side.

Color Wheel 1

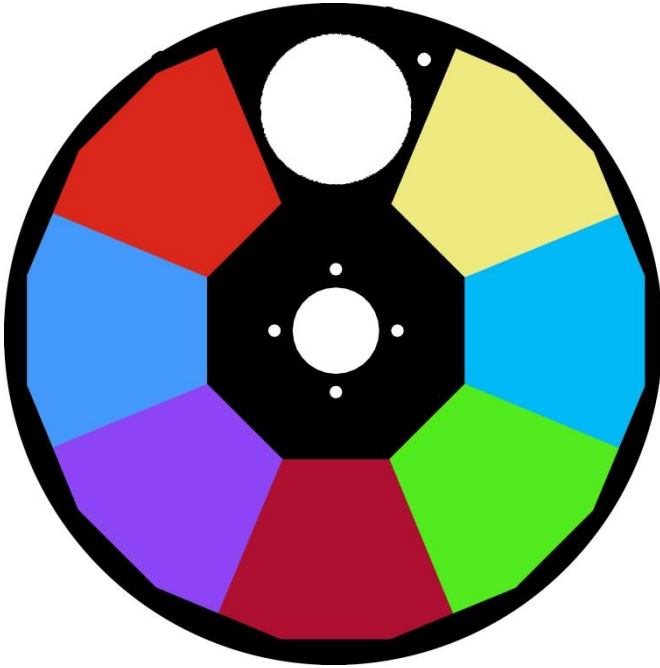

Fig. 10

Color Wheel 2

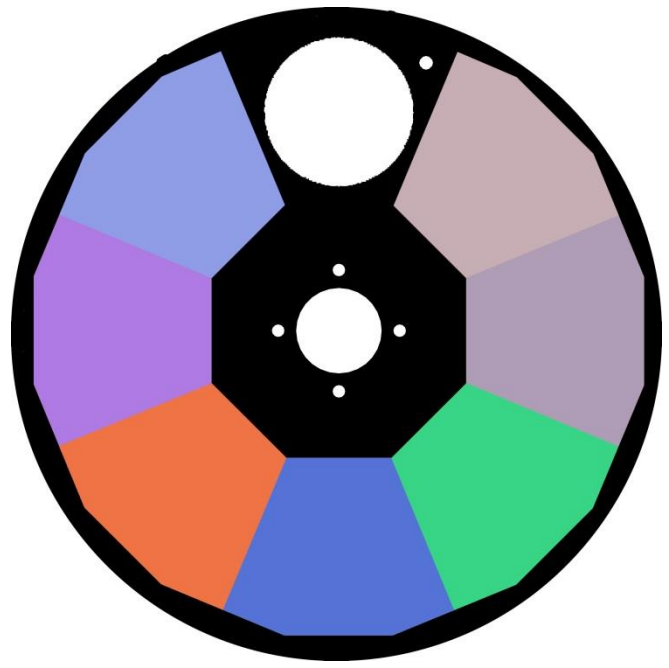

Fig. 11

Rotating Gobo-wheel



Fig. 12

Static Gobo-wheel

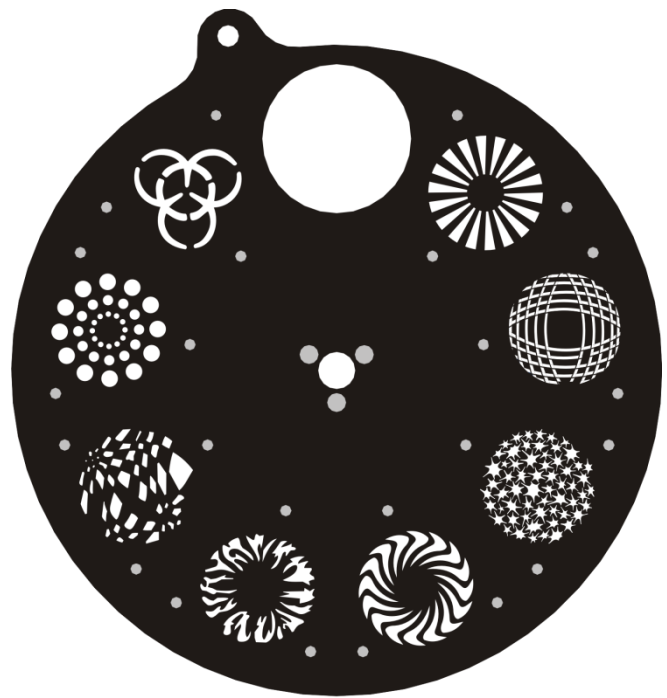

Fig. 13

Battery Replacement

(must be carried out by a qualified technician!)

- 01) Unplug the unit from the electric power source.
- 02) Remove the 6 screws on the front side of the Infinity.
- 03) Gently pull the front cover from the device.
- 04) Disconnect the plug from the PCB.
- 05) Remove the 2 screws holding the battery pack in place.
- 06) Replace the old battery pack with a new one.
- 07) Replace the maintenance cap and fasten all screws.

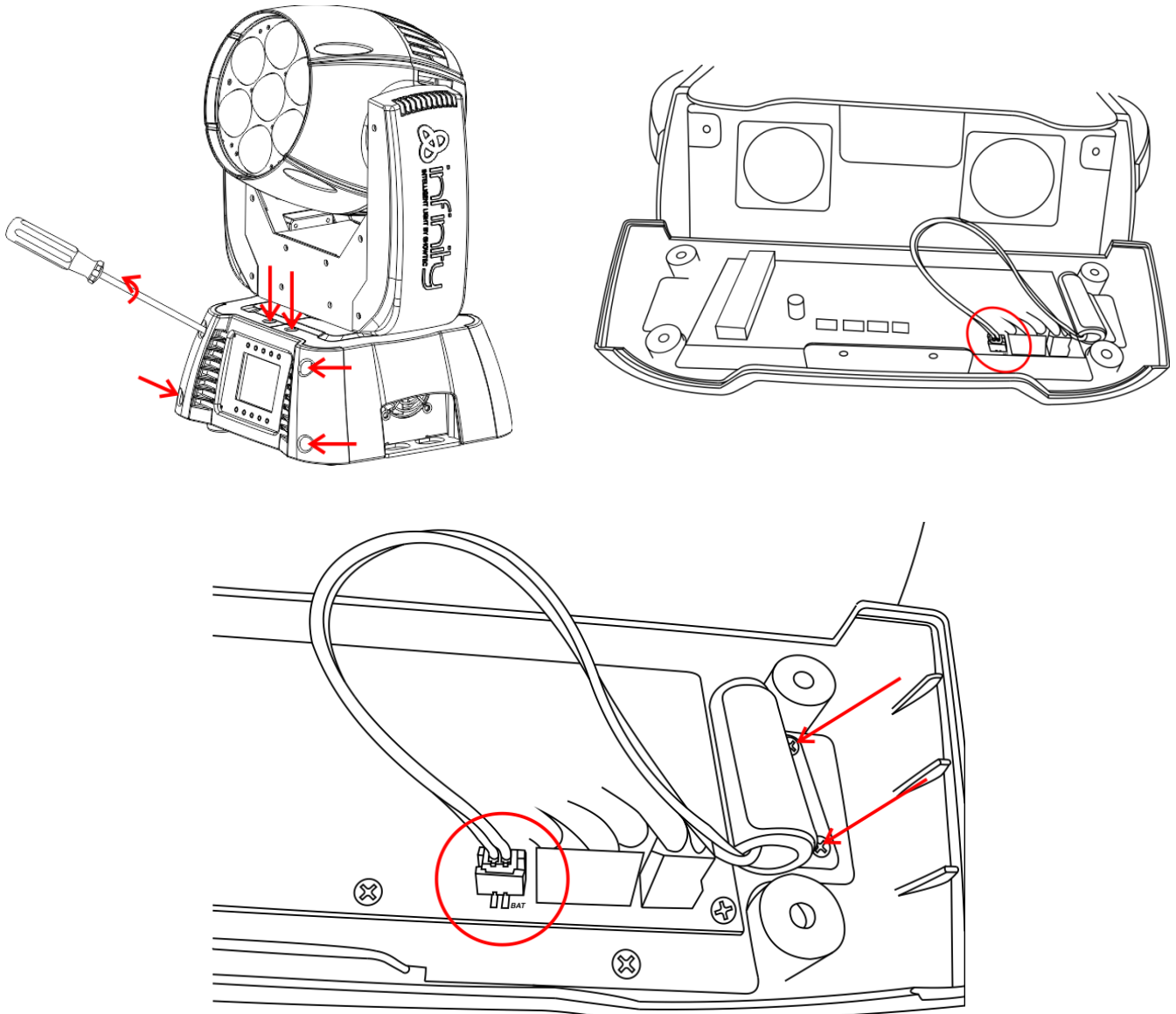

Fig. 07

Note: WARRANTY on batteries is only 6 months after date of purchase

When your battery remains dead after fully charging or it doesn't function or doesn't charge anymore, you can order a new battery.

The spare part number for the Infinity Series Battery : SPC1157

Troubleshooting

No Light

This troubleshooting guide is meant to help solve simple problems.

If a problem occurs, carry out the steps below in sequence until a solution is found. Once the unit operates properly, do not carry out following steps.

If the light effect does not operate properly, refer servicing to a technician.

Response: Suspect four potential problem areas as: factory reset, the power supply, the LED, the fuse.

- 01) First try to reset the device to its original factory default settings (3-Settings Menu Menu see page 15).
- 02) Power supply. Check that the unit is plugged into an appropriate power supply.
- 03) The LEDs. Return the Infinity to your Infinity dealer.
- 04) The fuse. Replace the fuse. See page 23 for replacing the fuse.
- 05) If all of the above appears to be O.K., plug the unit in again.
- 06) If you are unable to determine the cause of the problem, do not open the Infinity, as this may damage the unit and the warranty will become void.
- 07) Return the device to your Infinity dealer.

No Response to DMX

Response: Suspect the DMX cable or connectors, a controller malfunction, a light effect DMX card malfunction.

- 01) Check the DMX setting. Make sure that DMX addresses are correct.
- 02) Check the DMX cable: Unplug the unit; change the DMX cable; then reconnect to electrical power. Try your DMX control again.
- 03) Determine whether the controller or light effect is at fault. Does the controller operate properly with other DMX products ? If not, take the controller in for repair. If so, take the DMX cable and the light effect to a qualified technician.

See next page for more problem solving.

Problem	Probable cause(s)	Remedy
One or more fixtures are completely dead.	No power to the fixture.	<ul style="list-style-type: none"> • Check that power is switched on and cables are plugged in.
	Primary fuse blown.	<ul style="list-style-type: none"> • Replace fuse.
Fixtures reset correctly, but all respond erratically or not at all to the controller.	The controller is not connected.	<ul style="list-style-type: none"> • Connect controller.
	3-pin XLR Out of the controller does not match XLR Out of the first fixture on the link (i.e. signal is reversed).	<ul style="list-style-type: none"> • Install a phase reversing cable between the controller and the first fixture on the link.
Fixtures reset correctly, but some respond erratically or not at all to the controller.	Poor data quality	<ul style="list-style-type: none"> • Check data quality. If much lower than 100 percent, the problem may be a bad data link connection, poor quality or broken cables, missing termination plug, or a defective fixture disturbing the link.
	Bad data link connection	<ul style="list-style-type: none"> • Inspect connections and cables. Correct poor connections. Repair or replace damaged cables.
	Data link not terminated with 120 Ohm termination plug.	<ul style="list-style-type: none"> • Insert termination plug in output jack of the last fixture on the link.
	Incorrect addressing of the fixtures.	<ul style="list-style-type: none"> • Check address setting.
	One of the fixtures is defective and disturbs data transmission on the link.	<ul style="list-style-type: none"> • Bypass one fixture at a time until normal operation is regained: unplug both connectors and connect them directly together. • Have the defective fixture serviced by a qualified technician.
Shutter closes suddenly	3-pin XLR Out on the fixtures does not match (pins 2 and 3 reversed).	<ul style="list-style-type: none"> • Install a phase-reversing cable between the fixtures or swap pin 2 and 3 in the fixture, that behaves erratically.
	The color wheel, gobowheel or a gobo has lost its index position and the fixture is resetting the effect.	<ul style="list-style-type: none"> • Contact a technician for servicing the problem persists.
No light or lamp cuts out intermittently	Fixture is too hot.	<ul style="list-style-type: none"> • Allow fixture to cool. • Clean fan. • Make sure air vents at control panel and front lens are not blocked. • Turn up the air conditioning .
	LEDs damaged	<ul style="list-style-type: none"> • Disconnect fixture and return to your dealer.
	The power supply settings do not match local AC voltage and frequency.	<ul style="list-style-type: none"> • Disconnect fixture. Check settings and correct if necessary.

Product Specification

Model:	Infinity iS-200 LED Spot
Input Voltage:	100-240 VAC
Continuous Power:	370W max. at full output
Fuse:	F7AL / 250V
Dimensions:	346 x 417 x 551 mm (LxWxH)
Weight:	21 kg

Operation and Programming

Signal pin OUT:	pin 1 earth, pin 2 (-), pin 3 (+)
Set Up and Addressing:	LED control panel
Pan/Tilt resolution:	8-16 bit
DMX Channels:	21 or 18
Signal input:	3-pin and 5-pin XLR male
Signal output:	3-pin and 5-pin XLR female

Electro-mechanical effects

- On-Board: Battery powered full color display including gravity sensor
- LED source the shutter is electronic not mechanical.
- On-Board: 16x2 Character display
- Gobo size: Glass gobo: 27,7 mm (gobo size); 23,4 mm (image diameter); 1 mm (gobo thickness)
- Metal gobo: 28,9 mm (gobo size); 25,3 mm (image diameter); 0,5 mm (gobo thickness)
- DMX-control via standard DMX-controller
- User-selectable Pan & Tilt ranges, 540° / 360° / 180°
- Reverse Pan / Tilt movement
- Special: Pan / Tilt movement, Color, Gobo blackout
- Pan 0° -- 540°, Tilt 0° -- 270°
- Pan/Tilt resolution: 16 bit
- Control: DMX-512, Master/Slave, Built-in Programs
- 10 Built in programs selectable by DMX
- Light Source: 200W White LED
- Gobowheel 1: Rotating Gobowheel with 2 glass + 5 metal gobos (Interchangeable)
- Gobowheel 2: Static Gobowheel with 8 metal gobos
- Gobo functions: Gobo-flow effect, Gobo shake
- Colorwheel 1: 7 dichroic-filters and white
- Colorwheel 2: 7 dichroic-filters and white
- Color functions: Split colors, Rainbow-flow effect
- Rotation: Bi-directional
- Prism: 3-facet prism
- Frost filter: Yes
- Output: 78.100 Lux @ 1m.
- Beam Angle: 17°
- Dimmer: 0-100%
- Strobe: 0-20Hz
- Focus: Motorized focus
- Variable motorized Iris (2-100%)
- Housing: Black Metal & Flame-retardant plastic
- Neutrik Powercon IN / OUT

Gobos

Colourwheel:	heat-resistant and intensify glass; dichroic glass coating
Max. ambient temperature t_a :	40°C; Max. housing temperature t_B : 80°C
Motor:	high quality stepping-motor controlled by microprocessors

Minimum distance:

Minimum distance from flammable surfaces:	0.5m
Minimum distance to lighted object:	1.3m

Design and product specifications are subject to change without prior notice.



Website: www.highlite.nl

Email: service@highlite.nl

Dimensions

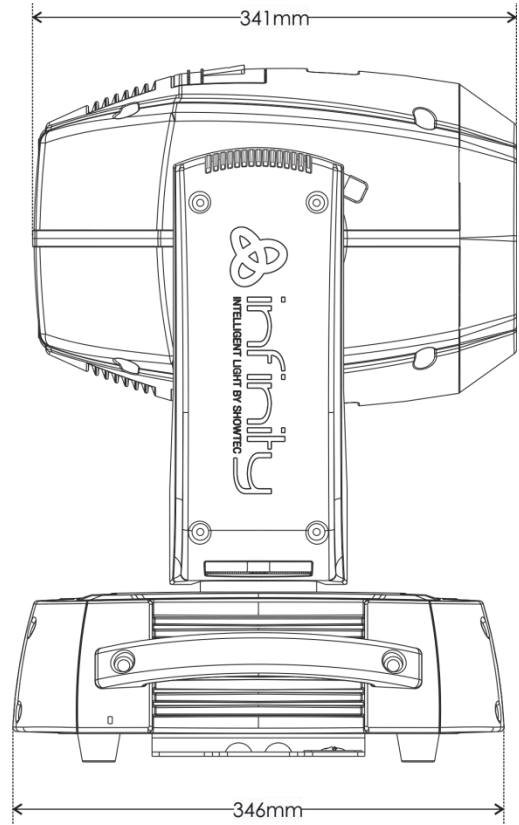
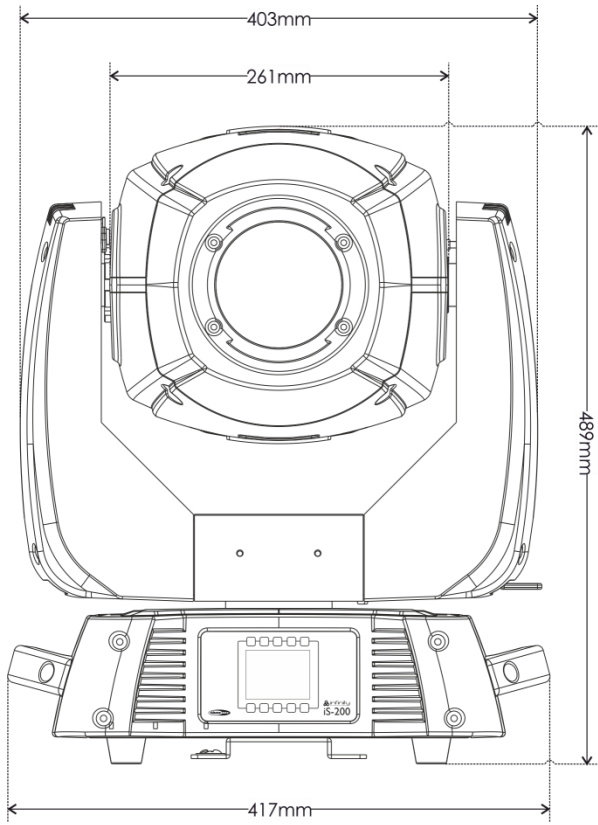



©2014 Infinity