

ENGLISH

HP-500 / HP-900 / HP-1500 / HP-2100/ HP-3000 V1

Ordercode:

D4175 D4176 D4177 D4178 D4179

Table of contents

Warning	2
Safety Instructions	2
Operating Determinations	4
Return Procedure	5
Claims.....	5
Description of the device	6
Frontside.....	7
D4175: HP-500	7
D4176: HP-900	7
D4177: HP-1500	7
D4178: HP-2100	8
D4179: HP-3000	8
Backside	9
D4175: HP-500	9
D4176: HP-900	9
D4177: HP-1500	9
D4178: HP-2100	10
D4179: HP-3000	10
Installation	11
Set Up and Operation	11
Mode Selection	11
Connection examples	12
Stereo Connection	12
Parallel Connection.....	13
Bridge Connection	14
Connection Cables	15
Maintenance	16
Troubleshooting	16
Product Specifications	17
Dimensions HP-500/ HP-900/ HP-1500/ HP-2100/ HP-3000	18

Warning



**For your own safety, please read this user manual carefully
before your initial start-up!**



Unpacking Instructions

Immediately upon receiving this product, carefully unpack the carton and check the contents to ensure that all parts are present and have been received in good condition. Notify the dealer immediately and retain packing material for inspection if any parts appear damaged from shipping or the carton itself shows signs of mishandling. Save the carton and all packing materials. In the event that a fixture must be returned to the factory, it is important that the fixture be returned in the original factory box and packing.

Your shipment includes:

- DAP Audio HP-500 / HP-900 / HP-1500 / HP-2100/ HP-3000
- IEC power cable (1,5 m)
- User manual

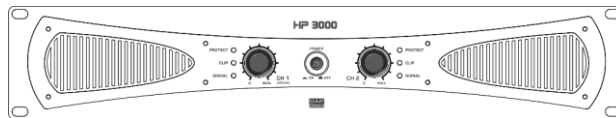
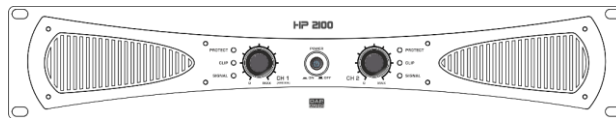
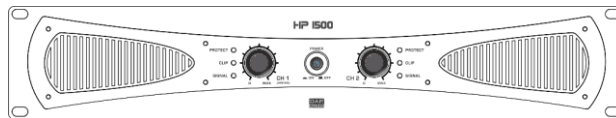
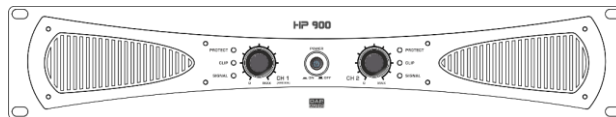
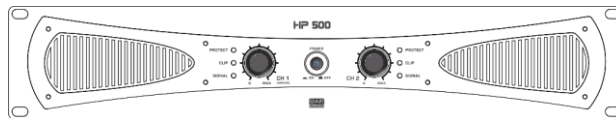

CAUTION!
Keep this device away from rain and moisture!
Unplug mains lead before opening the housing!



Safety Instructions

Every person involved with the installation, operation and maintenance of this system has to:

- be qualified
- follow the instructions of this manual



CAUTION! Be careful with your operations.
**With a dangerous voltage you can suffer
a dangerous electric shock when touching the wires!**



Before the initial start-up, please make sure that there is no damage caused by transportation. Should there be any, consult your dealer and do not use the system.

To maintain perfect condition and to ensure a safe operation, it is absolutely necessary for the user to follow the safety instructions and warning notes written in this manual.

Please consider that damages caused by manual modifications to the system are not subject to warranty.

This system contains no user-serviceable parts. Refer servicing to qualified technicians only.

IMPORTANT:

The manufacturer will not accept liability for any resulting damages caused by the non-observance of this manual or any unauthorized modification to the system.

- Always let the device cool down before cleaning or servicing.
- Always disconnect power from the mains, when system is not used. Only handle the power cord by the plug. Never pull out the plug by tugging the power cord.
- Always operate the unit with the AC ground wire connected to the electrical system ground.
- Avoid flames and do not put close to flammable liquids or gases.
- Avoid ground loops! Always be sure to connect the power amps and the mixing console to the same electrical circuit to ensure the same phase!
- Before changing the ground, always turn off your amplifier.
- Connecting amplifier outputs to oscilloscopes or other test equipment, while the amplifier is in bridge mode, may damage both, the amplifier and test equipment.
- Do not connect this device to a dimmer pack.
- Do not drive the inputs with a signal level higher than required to drive the equipment to full output.
- Do not insert objects into air vents.
- Do not open the device and do not modify the device.
- Do not open this device. Risk: hazardous radiation exposure.
- Do not switch the system on and off in short intervals, as this would reduce the system's life.
- Do not put your equipment next to TV, radio, etc., because of interference or distortion.
- If device is dropped or struck, disconnect mains power supply immediately. Have a qualified engineer inspect for safety before operating.
- If the system has been exposed to drastic temperature fluctuation (e.g. after transportation), do not switch it on immediately. The arising condensation water might damage your system. Leave the system switched off until it has reached room temperature.
- If you connect other parts of the system, beware ground loops.
- If your Dap Audio device fails to work properly, discontinue use immediately. Pack the unit securely (preferably in the original packing material) and return it to your Dap Audio dealer for service.
- In system setup, the amplifier's output power must be 50%-100% higher than the loaded loudspeakers rated power.
- In typical use, please set the volume to 0dB position.
- Make sure that the amplifier is turned down, before turning the power on or off. In this way you can avoid supersonic frequencies, which could damage your speakers.
- Make sure that the available voltage is not higher than stated on the rear panel.
- Make sure that the power cord is never crimped or damaged. Check the device and the power cord from time to time.
- Make sure that the signals coming into the mixer are balanced, otherwise hum could be created.
- Make sure you do not use the wrong kind of cables or defective cables.
- Make sure you use DI boxes to balance unbalanced signals; All incoming signals should be clear
- Never let the power cord come into contact with other cables! Handle the power cord and all connections with the mains with particular caution!
- Never remove warning or informative labels from the unit.
- Never use anything to cover the ground contact.
- Only use device indoors, avoid contact with water or other liquids.
- Please read this manual carefully and keep it for future reference.

- Please turn off the power switch, when replacing the power cord, signal cable or selecting the input mode switch.
- Prevent distortion! Make sure that all components connected to the device have sufficient power ratings. Otherwise, distortion will be generated because the components are operated at their limits.
- Sometimes, when you want to send one signal to more than one amplifier, you should use a signal distributor.
- The best way to avoid ground loops is connecting the electrical system ground to one central point ("star" system). In this case the mixer can act as a central point.
- This device falls under protection class I. Therefore it is essential to connect the yellow/green conductor to earth.
- The user is responsible for correct positioning and operating of the HP amplifier. The manufacturer will not accept liability for damages caused by the misuse or incorrect installation of this device.
- Repairs, servicing and electric connection must be carried out by a qualified technician.
- WARRANTY: Till one year after date of purchase.

Operating Determinations

This system is not designed for permanent operation. Consistent operation breaks will ensure that the system will serve you for a long time without defects.

If this system is operated in any other way than the one described in this manual, the product may suffer damages and the warranty becomes void.

Any other operation may lead to dangers like short-circuit, burns, electric shock, etc.

You endanger your own safety and the safety of others !

Improper installation can cause serious damage to people and property !



Return Procedure

Returned merchandise must be sent prepaid and in the original packing, call tags will not be issued. Package must be clearly labeled with a Return Authorization Number (RMA number). Products returned without an RMA number will be refused. Highlite will not accept the returned goods or any responsibility. Call Highlite 0031-455667723 or mail offersales@highlite.nl and request an RMA prior to shipping the fixture. Be prepared to provide the model number, serial number and a brief description of the cause for the return. Be sure to properly pack fixture, any shipping damage resulting from inadequate packaging is the customer's responsibility. Highlite reserves the right to use its own discretion to repair or replace product(s). As a suggestion, proper UPS packing or double-boxing is always a safe method to use.

Note: If you are given an RMA number, please include the following information on a piece of paper inside the box:

- 01) Your name
- 02) Your address
- 03) Your phone number
- 04) A brief description of the symptoms

Claims

The client has the obligation to check the delivered goods immediately upon delivery for any shortcomings and/or visible defects, or perform this check after our announcement that the goods are at their disposal. Damage incurred in shipping is the responsibility of the shipper; therefore the damage must be reported to the carrier upon receipt of merchandise.

It is the customer's responsibility to notify and submit claims with the shipper in the event that a device is damaged due to shipping. Transportation damage has to be reported to us within one day after receipt of the delivery.

Any return shipment has to be made post-paid at all times. Return shipments must be accompanied with a letter defining the reason for return shipment. Non-prepaid return shipments will be refused, unless otherwise agreed in writing.

Complaints against us must be made known in writing or by fax within 10 working days after receipt of the invoice. After this period complaints will not be handled anymore.

Complaints will only then be considered if the client has so far complied with all parts of the agreement, regardless of the agreement of which the obligation is resulting.

Description of the device

The HP series is a family of powerful amplifiers which guarantee high output level. There are 5 available versions: HP-500, HP-900, HP-1500, HP-2100 and HP-3000.

Features

	HP-500	HP-900	HP-1500	HP-2100	HP-3000
Stereo 2Ohm:	Not allowed				
Stereo 4Ohm:	2 x 200W RMS	2 x 450W RMS	2 x 750W RMS	2 x 1000W RMS	2 x 1400W RMS
Stereo 8Ohm:	2 x 150W RMS	2 x 350W RMS	2 x 500W RMS	2 x 700W RMS	2 x 1200W RMS
Bridge 2Ohm:	Not allowed				
Bridge 4Ohm:	Not allowed				
Bridge 8Ohm:	1 x 400W RMS	1 x 900W RMS	1 x 1500W RMS	1 x 2000W RMS	1 x 2800W RMS
Frequency response:	10Hz –20kHz, +0/-1dB				
THD:	<0.5%				
S/N rate:	>100dB A-weighted				
Crosstalk:	>75dB				
Damping factor:	>100 8Ohm				
Gain:	32dB	32dB	34.5dB	34.5dB	36dB
Input sensitivity:	0,775V (+/-1dBv)	0,85V (+/-1dBv)	0,775V (+/-1dBv)	0,85V (+/-1dBv)	0,775V (+/-1dBv)
Input impedance:	20kOhm balanced, 10kOhm unbalanced				
Output Mode	Stereo/ Parallel/ Bridge				
Amp technology:	Class AB	Class AB	Class H	Class H	Class H 3-step
Protection:	Clip Limiter (Fixed), Short Circuit, Overheat, Overload, DC Voltage				
Cooling:	Forced-air by axial fan				
Air flow:	Front to back				
Input connectors:	3-pin XLR IN				
Output connectors:	Speakon OUT				
Power connector:	IEC				
Input voltage:	210-240V AC, 50/60Hz				
Max. power consumption (2x 4Ohm):	600W	1400W	2210W	2850W	3800W
Main Fuse:	Auto Fuse, 3A, resettable	Auto Fuse, 6A, resettable	Auto Fuse, 10A, resettable	Auto Fuse, 15A, resettable	Auto Fuse, 20A, resettable
Fan:	24V, 0.3A, 80x80x25mm				
Dimensions:	483 x 310 x 88 mm (LxWxH) 19" x 2HE				
Weight:	8 kg	10 kg	12,7 kg	14 kg	17 kg

Frontside

D4175: HP-500

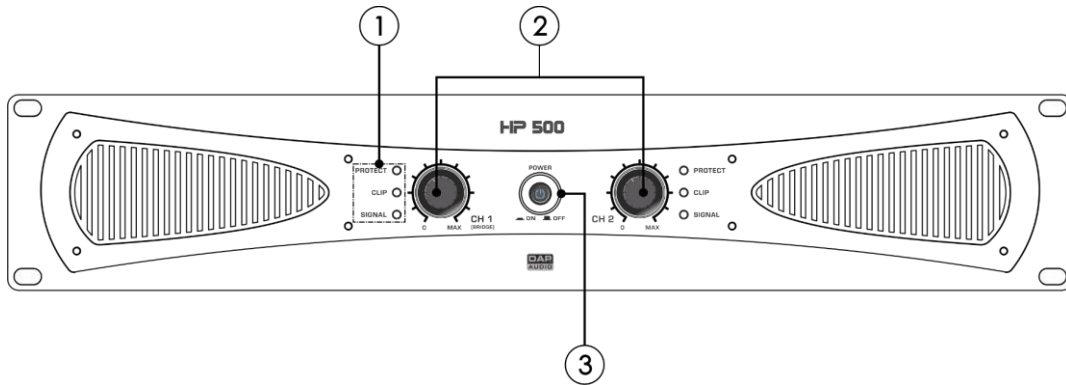

Fig. 01

D4176: HP-900

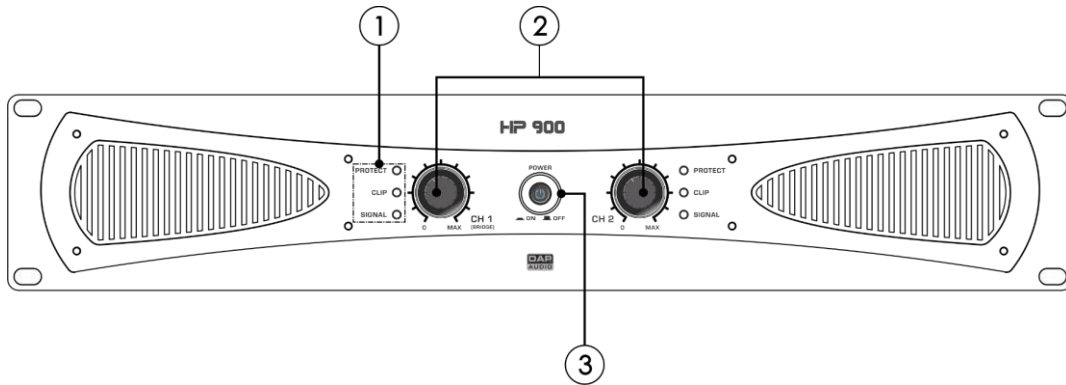

Fig. 02

D4177: HP-1500

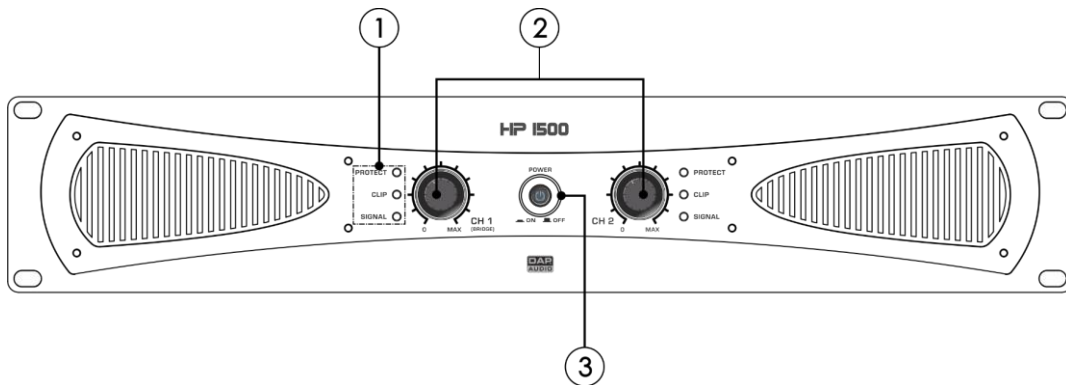

Fig. 03

D4178: HP-2100

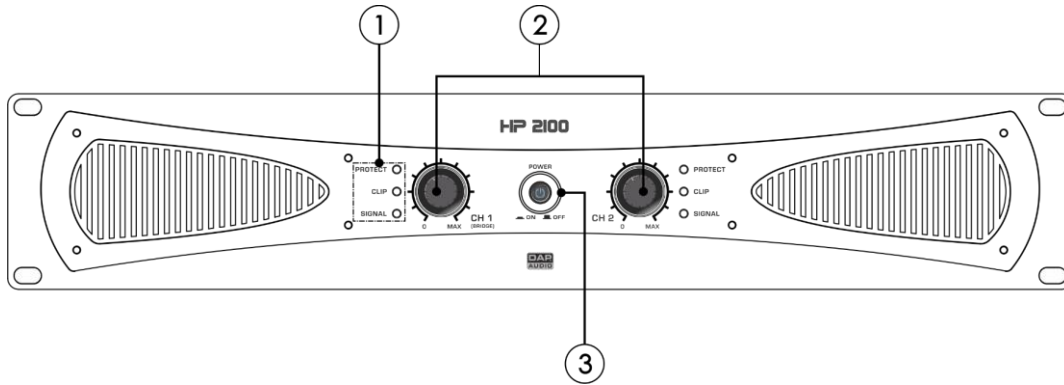

Fig. 04

D4179: HP-3000

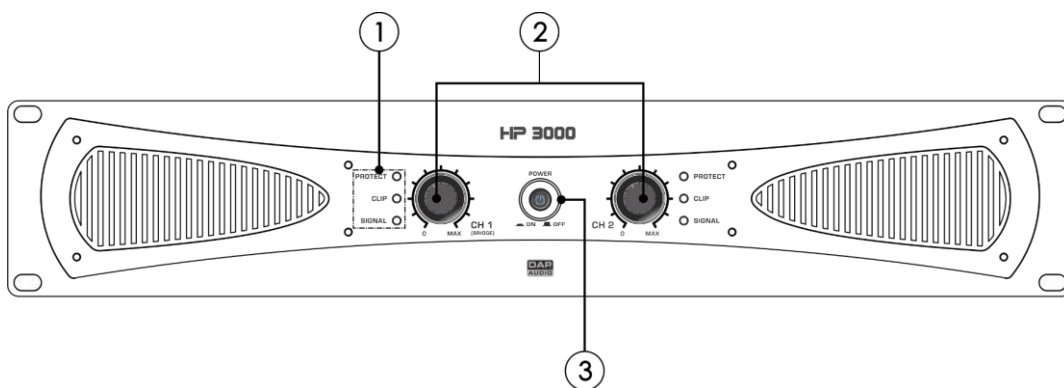

Fig. 05

- ① **Power Button ON/OFF**
Press the button to turn the device on/off.
- ② **Gain controls (CH A/B)**
Turn the controls to set the corresponding channel's gain level.
- ③ **CLIP, SIGNAL, PROTECT LEDs**

- CLIP: When the LED lights in red, it indicates distortion. In this case, decrease your source signal level until the LED turns off. Please keep in mind that the amplifier itself cannot correct any distortion.
- SIGNAL: When the LED lights in green, it means that the HP is operating within its safety limits.
- PROTECT: The LED will light in orange when the amplifier is in protection mode. Switch off the device and find out what the problem is. The amplifier is protected against overheating, overload, short circuit, etc. Decrease the source signal level and/or improve air circulation in the room where the HP is installed.

Backside

D4175: HP-500

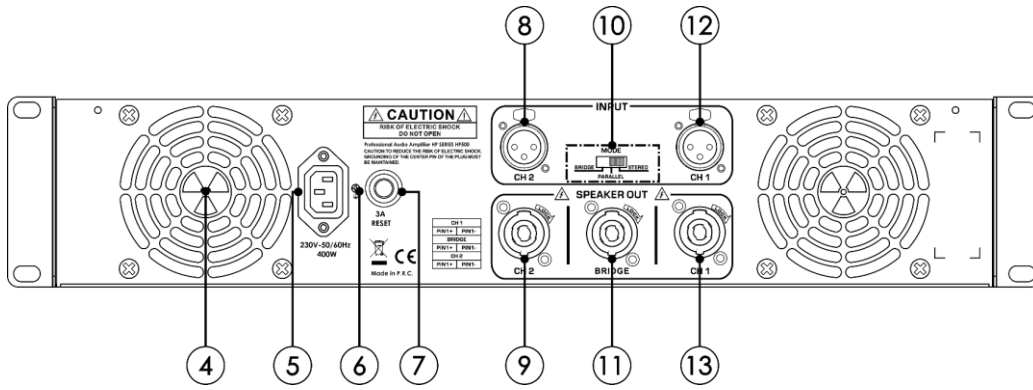

Fig. 06

D4176: HP-900

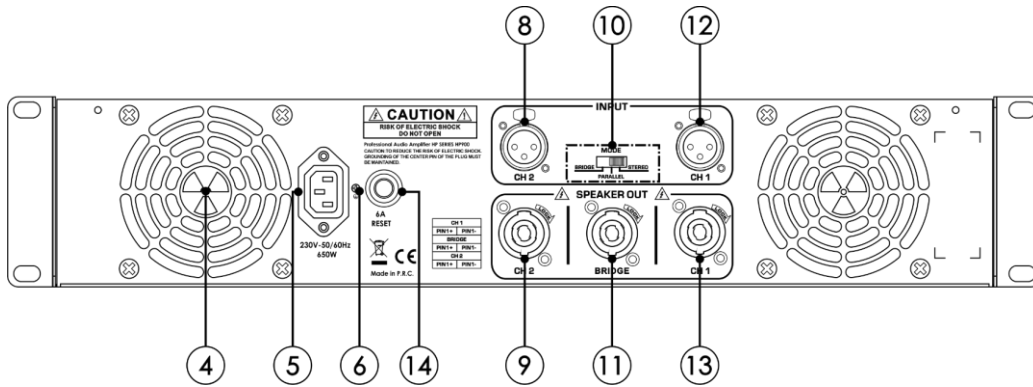

Fig. 07

D4177: HP-1500

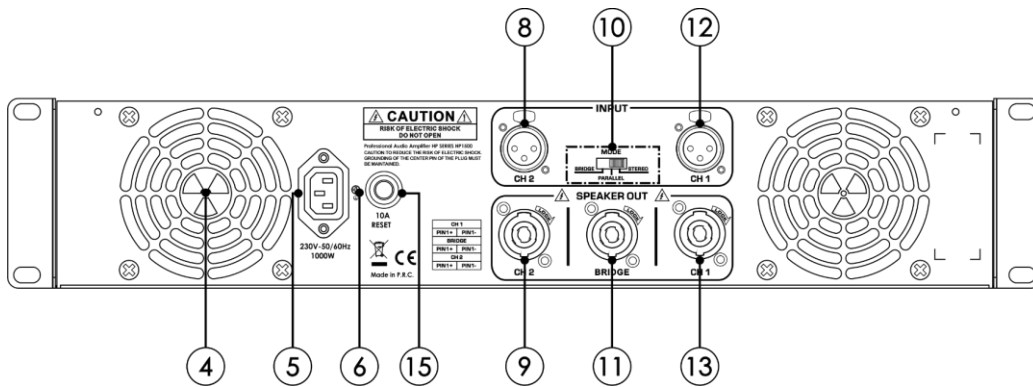

Fig. 08

D4178: HP-2100

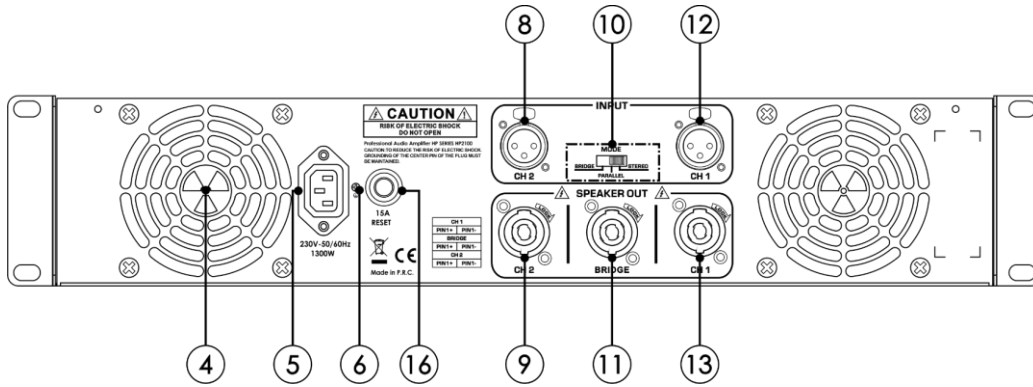

Fig. 09

D4179: HP-3000

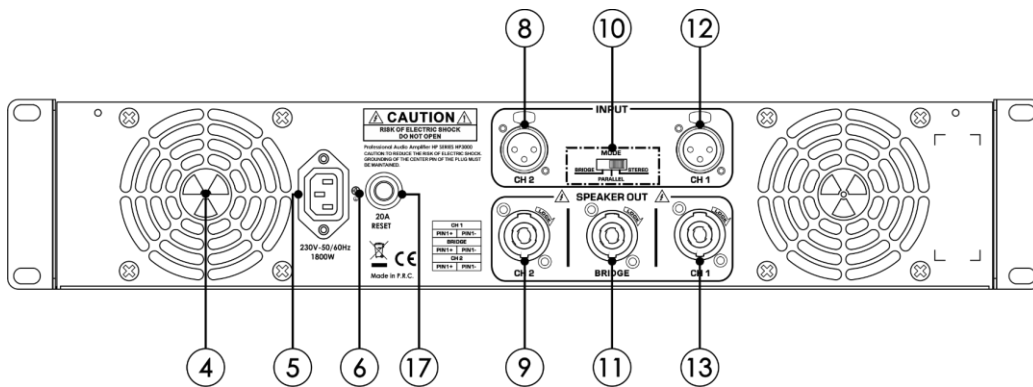

Fig. 10

- ④ **Air exhaust**
Do not block the air exhaust as it may cause overheating and/or other serious damage.
- ⑤ **IEC power connector IN 230V-50/60Hz**
400W/650W/1000W/1300W/1800W
- ⑥ **Ground/earth connection**
- ⑦ **Auto Fuse, 3A, resettable**
- ⑧ **CH 2, 3-pin XLR connector IN (unbalanced/balanced)**
Connect low impedance equipment with balanced/unbalanced line level outputs.
- ⑨ **CH 2, Speakon connector OUT**
Connect the device to speakers.
- ⑩ **Mode switch**
With this switch you can choose between the 3 operation modes: bridge, parallel and stereo.
 - STEREO: 2 inputs (channel 1 and 2) and 2 outputs are used.
 - PARALLEL: 1 input (channel 1) and 2 outputs are used.
 - BRIDGE: 1 input (channel 1) and 1 output are used (only use at 8Ohm).
- ⑪ **Bridge Speakon connector OUT**
Connect the device to speakers in Bridge mode.
- ⑫ **CH 1, 3-pin XLR connector IN (unbalanced/balanced)**
Connect low impedance equipment with balanced/unbalanced line level outputs.
- ⑬ **CH 1, Speakon connector OUT**
Connect the device to speakers.
- ⑭ **Auto Fuse, 6A, resettable**
- ⑮ **Auto Fuse, 10A, resettable**
- ⑯ **Auto Fuse, 15A, resettable**
- ⑰ **Auto Fuse, 20A, resettable**

Installation

Remove all packing materials from the HP-500 / HP-900 / HP-1500 / HP-2100/ HP-3000. Check if all foam and plastic padding is removed. Fit the equipment to a 19" rack. Connect all cables. **Always disconnect from electric mains power supply before cleaning or servicing.** Damages caused by non-observance are not subject to warranty.

Set Up and Operation

Before plugging the unit in, always make sure that the power supply matches the product specification voltage. Do not attempt to operate a 120V specification product on 240V power, or vice versa. Install this device on a flat surface, not bending or curved. Do not supply power before all components of the system are set up and connected properly.

Mode Selection

With the mode switch you can choose the desired mode, stereo, parallel or bridge.

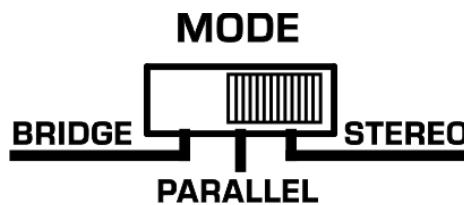

Fig. 11

Connection examples

Stereo Connection

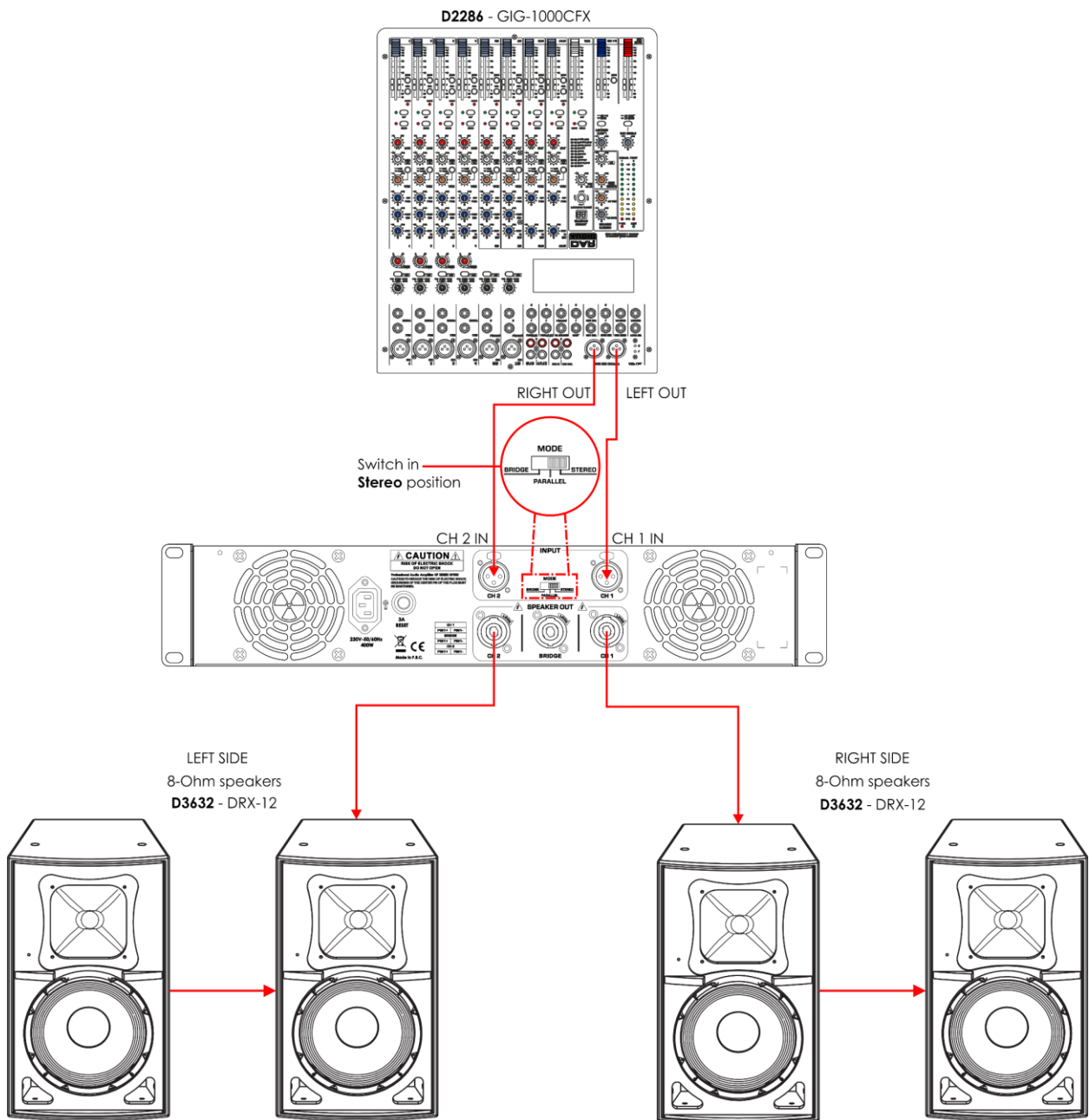

Fig. 12

Parallel Connection

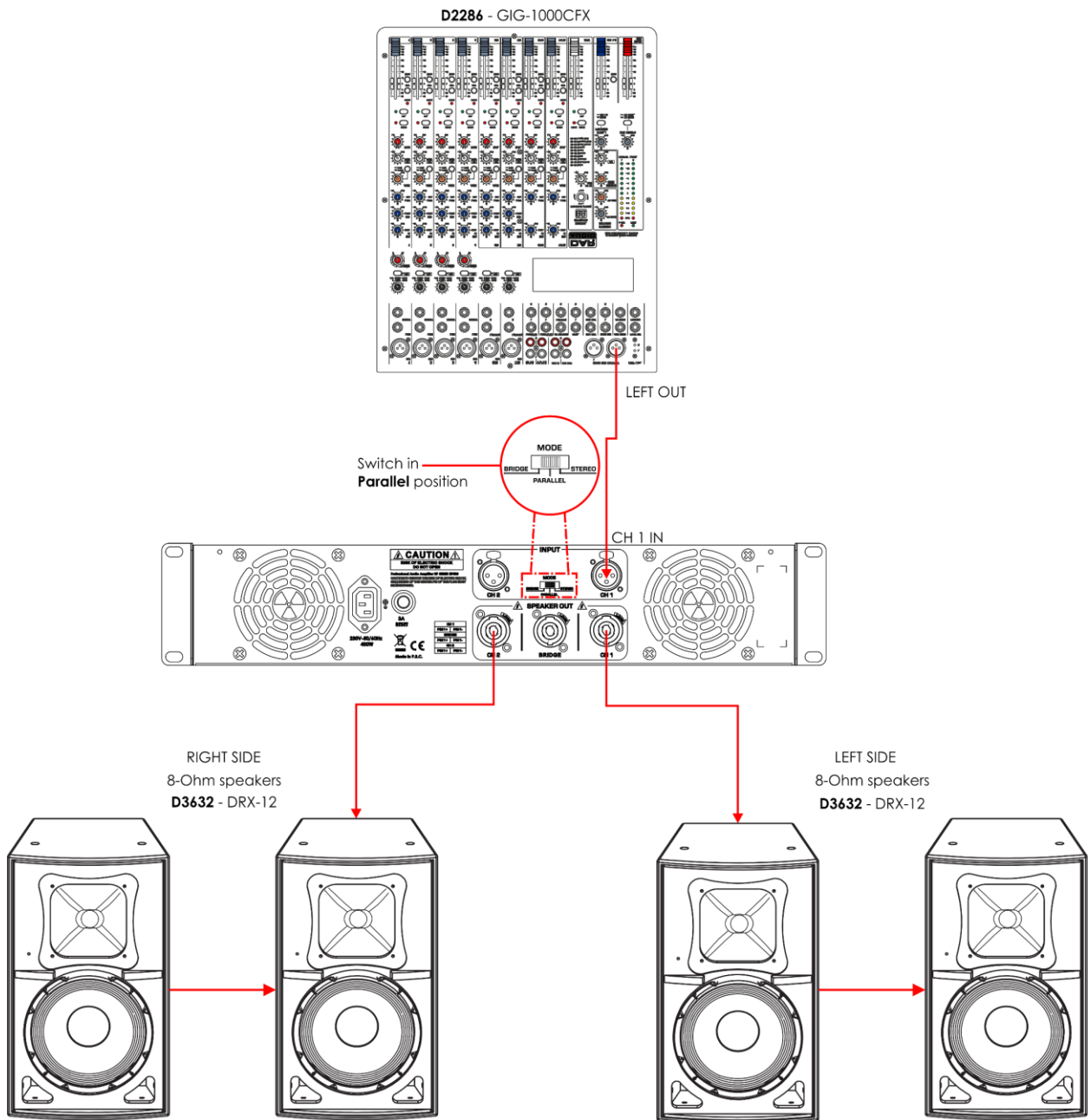

Fig. 13

Bridge Connection

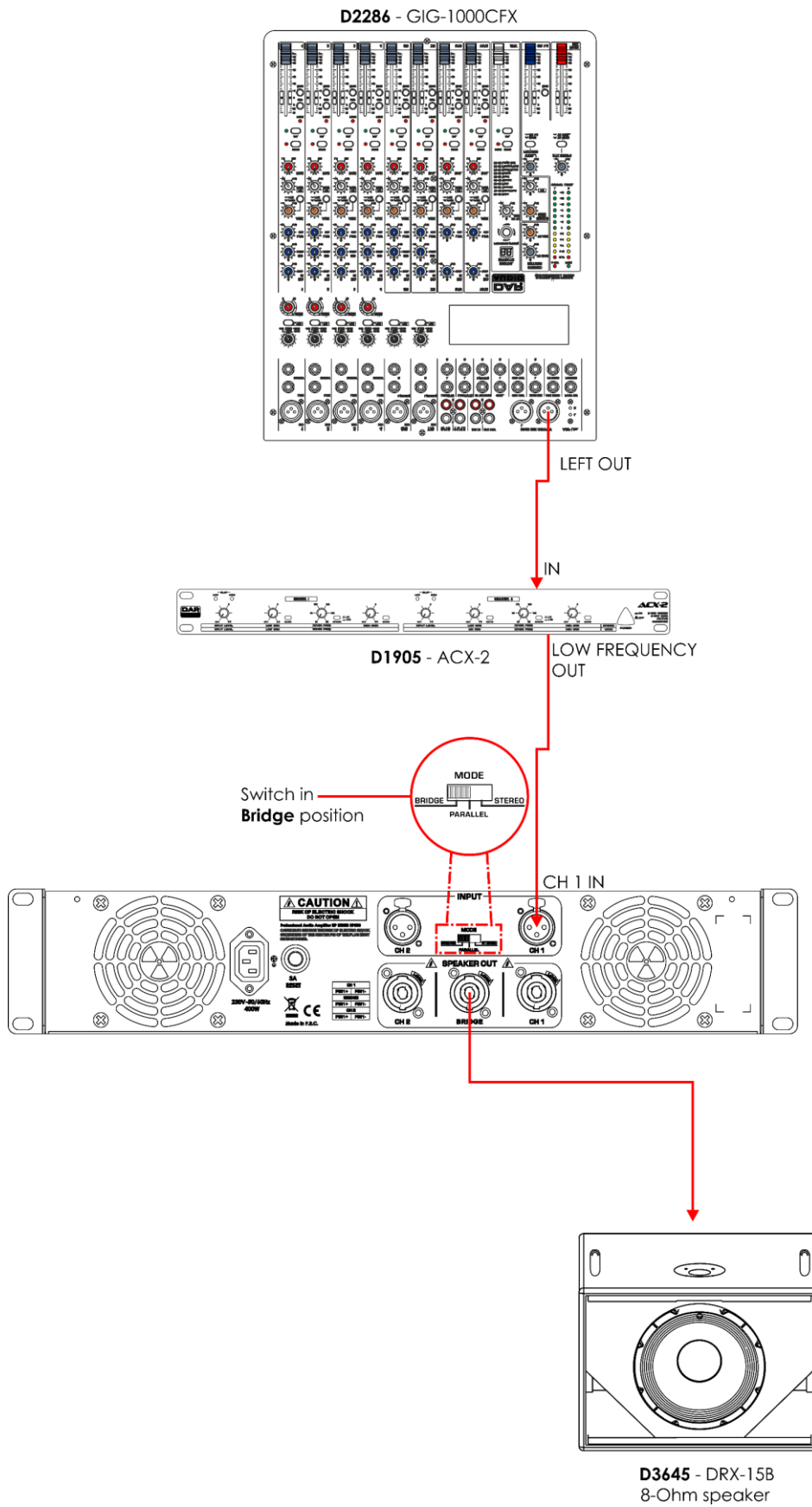
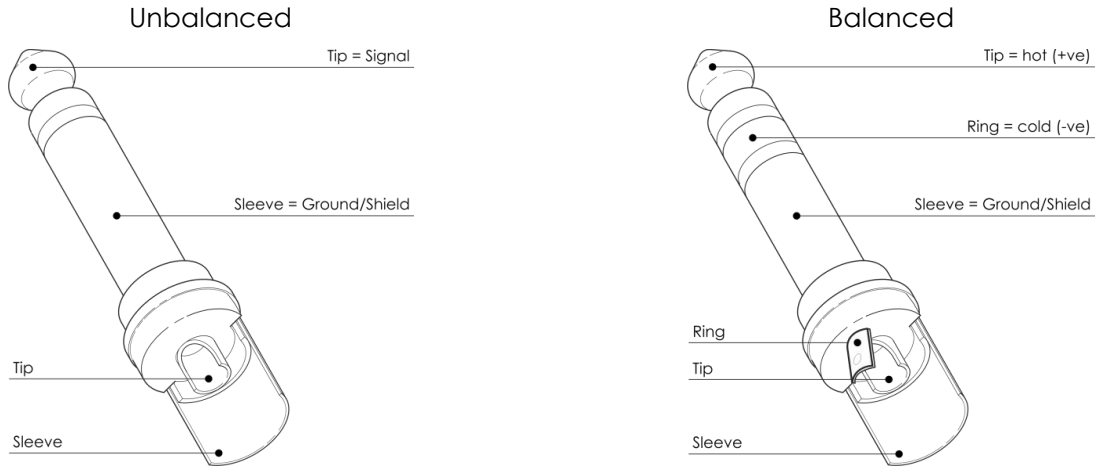

Fig. 14

Connection Cables

Take care of your cables by always holding them by the connectors and avoiding knots and twists when coiling them: This gives the advantage of increasing their lifespan and reliability. Periodically check your cables. A great number of problems (faulty contacts, ground hum, discharges, etc.) are caused entirely by using unsuitable or faulty cables.



For these applications the unit provides 1/4" TRS and XLR connectors to easily interface with most professional audio devices. Follow the configuration examples below for your particular connection.

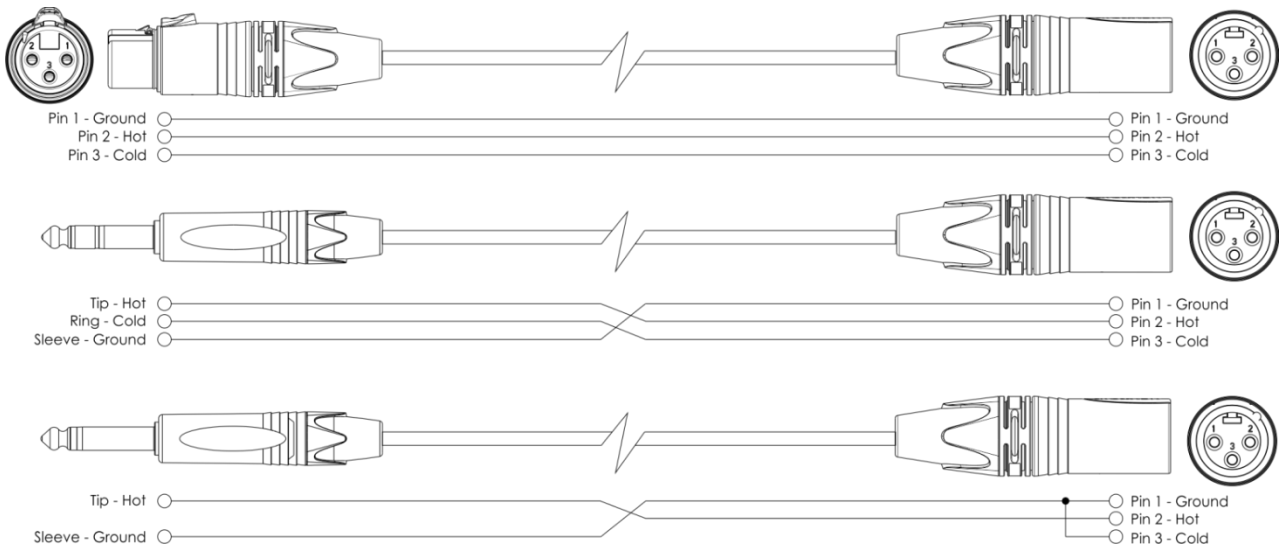

Maintenance

The HP-500 / HP-900 / HP-1500 / HP-2100 / HP-3000 require almost no maintenance. However, you should keep the unit clean.

Disconnect the mains power supply, and then wipe the cover with a damp cloth. Do not immerse in liquid. Do not use alcohol or solvents.

Keep connections clean. Disconnect electric power, and then wipe the audio connections with a damp cloth. Make sure connections are thoroughly dry before linking equipment or supplying electric power.

Troubleshooting

HP-500 / HP-900 / HP-1500 / HP-2100 / HP-3000

This troubleshooting guide is meant to help solve simple problems. If a problem occurs, carry out the steps below in sequence until a solution is found. If the unit operates properly, do not carry out following steps.

- 01) If the device does not operate properly, unplug the device.
- 02) Check power from the wall, all cables, connections, etc.
- 03) If all appears to be O.K., plug the unit in again.
- 04) If nothing happens after 30 seconds, unplug the device.
- 05) Return the device to your DAP Audio dealer.

Product Specifications

	HP-500	HP-900	HP-1500	HP-2100	HP-3000
Stereo 2Ohm:	Not allowed				
Stereo 4Ohm:	2 x 200W RMS	2 x 450W RMS	2 x 750W RMS	2 x 1000W RMS	2 x 1400W RMS
Stereo 8Ohm:	2 x 150W RMS	2 x 350W RMS	2 x 500W RMS	2 x 700W RMS	2 x 1200W RMS
Bridge 2Ohm:	Not allowed				
Bridge 4Ohm:	Not allowed				
Bridge 8Ohm:	1 x 400W RMS	1 x 900W RMS	1 x 1500W RMS	1 x 2000W RMS	1 x 2800W RMS
Frequency response:	10Hz –20kHz, +0/-1dB				
THD:	<0.5%				
S/N rate:	>100dB A-weighted				
Crosstalk:	>75dB				
Damping factor:	>100 8Ohm				
Gain:	32dB	32dB	34.5dB	34.5dB	36dB
Input sensitivity:	0,775V (+/-1dBv)	0,85V (+/-1dBv)	0,775V (+/-1dBv)	0,85V (+/-1dBv)	0,775V (+/-1dBv)
Input impedance:	20kOhm balanced, 10kOhm unbalanced				
Output Mode	Stereo/ Parallel/ Bridge				
Amp technology:	Class AB	Class AB	Class H	Class H	Class H 3-step
Protection:	Clip Limiter (Fixed), Short Circuit, Overheat, Overload, DC Voltage				
Cooling:	Forced-air by axial fan				
Air flow:	Front to back				
Input connectors:	3-pin XLR IN				
Output connectors:	Speakon OUT				
Power connector:	IEC				
Input voltage:	210-240V AC, 50/60Hz				
Max. power consumption (2x 4Ohm):	600W	1400W	2210W	2850W	3800W
Main Fuse:	Auto Fuse, 3A, resettable	Auto Fuse, 6A, resettable	Auto Fuse, 10A, resettable	Auto Fuse, 15A, resettable	Auto Fuse, 20A, resettable
Fan:	24V, 0.3A, 80x80x25mm				
Dimensions:	483 x 310 x 88 mm (LxWxH) 19" x 2HE				
Weight:	8 kg	10 kg	12,7 kg	14 kg	17 kg

Design and product specifications are subject to change without prior notice.



Website: www.Dap-audio.info
Email: service@highlite.nl

Dimensions HP-500/ HP-900/ HP-1500/ HP-2100/ HP-3000

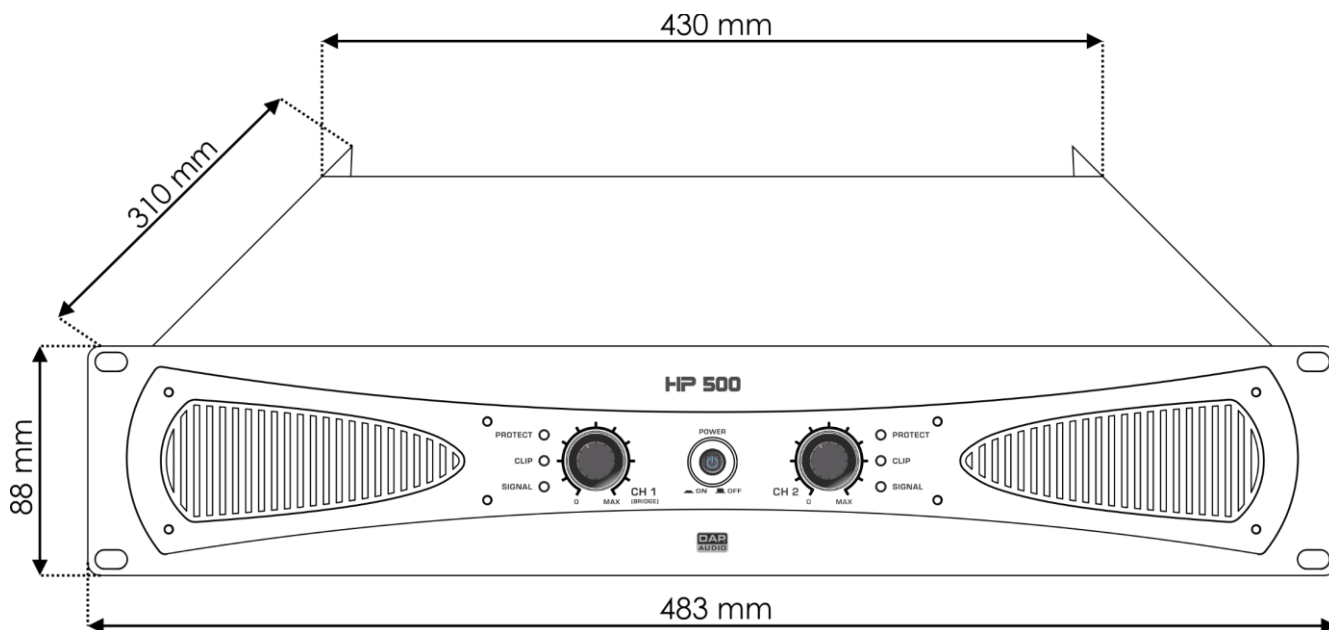



©2018 DAP Audio