

ROBE

ROBIN[®] Painte

ROBIN[®] Painte EP

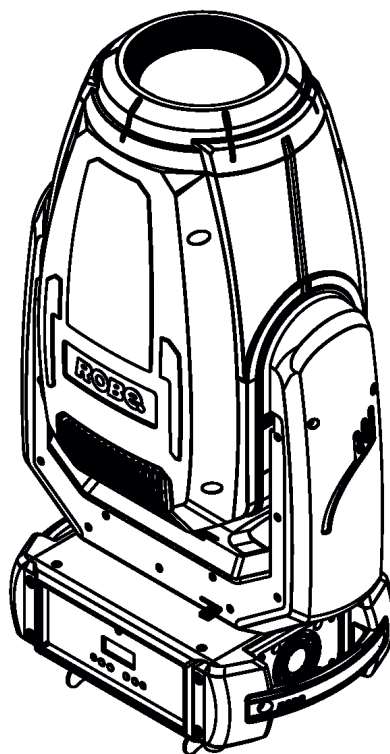

ROBE
Innovative
Technology

USER MANUAL

Version 1.0

ROBE[®] lighting s.r.o. • Czech Republic • www.robe.cz

Robin Painte

Robin Painte EPS

Table of contents

1. Safety instructions	3
2. Fixture exterior view	5
3. Installation	6
3.1 Connection to the mains	6
3.2 Rigging the fixture	7
3.3 DMX-512 connection.....	9
3.4 Ethernet connection	10
3.5. Wireless DMX operation	11
3.6. Replacing rotating gobos	12
4. Remotely controllable functions	13
5. Control menu map	15
6. Control menu	19
6.1 Tab " Address"	20
6.2 Tab "Information"	21
6.3 Tab "Personality"	24
6.4 Tab "Manual Control".....	26
6.5 Tab "Stand-alone"	26
6.6 Tab "Service"	27
7. RDM	30
8. Error and information messages	31
9. Technical Specifications	34
10. Maintenance and cleaning	37
10.1 Replacing the fuse	37
10.2 Checking plastic parts of the fixture	38
10.3 Disposing of the product	38
11. ChangeLog	39
12. Appendix	40
12.1 Changing the LED light source	40
12.2 Obtaining information about the LED light source by mobile phone	42

**FOR YOUR OWN SAFETY, PLEASE READ THIS USER MANUAL CAREFULLY
BEFORE POWERING OR INSTALLING YOUR ROBIN PAINTE !**

Save it for future reference.

This device has left our premises in absolutely perfect condition. In order to maintain this condition and to ensure a safe operation, it is absolutely necessary for the user to follow the safety instructions and warning notes written in this manual.

The manufacturer will not accept liability for any resulting damages caused by the non-observance of this manual or any unauthorized modification to the device.

Please consider that damages caused by manual modifications to the device are not subject to warranty.

The Robin Painte was designed for indoor use and it is intended for professional application only. It is not for household use.

1. Safety instructions

DANGEROUS VOLTAGE CONSTITUTING A RISK OF ELECTRIC SHOCK IS PRESENT WITHIN THIS UNIT!

Make sure that the available voltage is not higher than stated on the rear panel of the fixture. This fixture should be operated only from the type of power source indicated on the marking label. If you are not sure of the type of power supplied, consult your authorized distributor or local power company.

WARNING! This unit does not contain an ON/OFF switch. Always disconnect power input cable to completely remove power from unit when not in use or before cleaning or servicing the unit.

Make sure that the power cord is never crimped or damaged by sharp edges. Check the fixture and the power cord from time to time.

Refer servicing to qualified service personnel.

This fixture falls under protection class I. Therefore this fixture has to be connected to a mains socket outlet with a protective earthing connection.

Do not connect this fixture to a dimmer pack.

LED light emission. Risk of eye injury. Do not look into the beam at short distance of the of the product. Do not view the light output with optical instruments or any device that may concentrate the beam.

If the fixture has been exposed to drastic temperature fluctuation (e.g. after transportation), do not switch it on immediately. The arising condensation water might damage your device. Leave the device switched off until it has reached room temperature.

Avoid brute force when installing or operating the fixture.

This fixture was designed for indoor use only, do not expose this unit to rain or use near water.

When choosing the installation spot, please make sure that the fixture is not exposed to extreme heat, moisture or dust.

Air vents and slots in the fixture's head and base are provided for ventilation, to ensure reliable operation of the device and to protect it from overheating.

Do not block the front lens with any object when the fixture is under operation.

CAUTION! Risk group 2, RG-2



The cooling openings should never be covered with cloth or other materials, and never must be blocked.

This fixture should not be placed in a built-in installation unless proper ventilation is provided.

Only operate the fixture after having checked that the housing is firmly closed and all screws are tightly fastened.

Always use a secondary safety wire when rigging this fixture.

Make sure that the area below the installation place is blocked when rigging, de-rigging or servicing the fixture.

The fixture becomes very hot during operation. Allow the fixture to cool approximately 20 minutes prior to manipulate with it.

Operate the fixture only after having familiarized with its functions. Do not permit operation by persons not qualified for operating the fixture. Most damages are the result of unprofessional operation!

Please use the original packaging if the fixture is to be transported.

Please consider that unauthorized modifications on the fixture are forbidden due to safety reasons!

If this device will be operated in any way different to the one described in this manual, the product may suffer damages and the guarantee becomes void. Furthermore, any other operation may lead to dangers like short-circuit, burns, electric shock, crash etc.

Immunity of the equipment is designed for electromagnetic environments E1, E2, E3 according to the standard EN55103-2 ed.2 Electromagnetic compatibility. Product family standard for audio, video, audiovisual and entertainment lighting control apparatus for professional use. Part 2: Immunity.

The product (covers and cables) must not be exposed to a high frequency electromagnetic field higher than 3V/m.

The installation company should check levels of possible interferences above the tested levels E1,E2,E3 given by this standard (e.g. transmitters in surrounding area) before installing the equipment.

Emission of the equipment complies with the standard EN55032 Electromagnetic compatibility of multimedia equipment – Emission Requirements according to class B.

To avoid damage of the internal optical system of the fixture, never let the sunlight or other fixture lights directly to the front lens , even when the fixture is not working !

2. Fixture exterior view

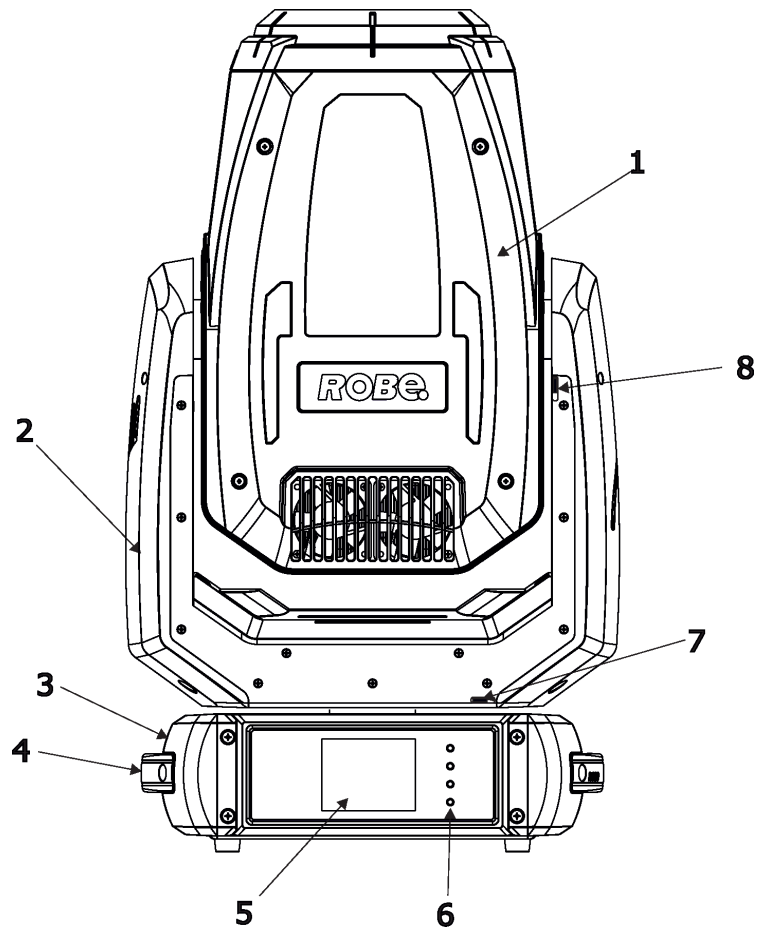

Rear panel of the base

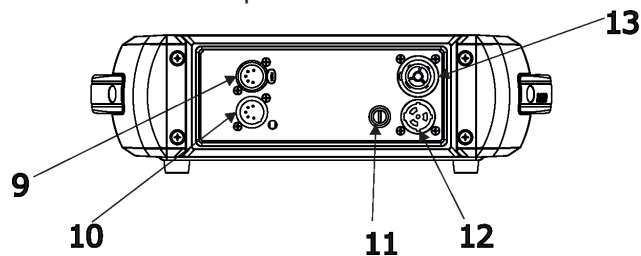

Rear panel of the base - EP version

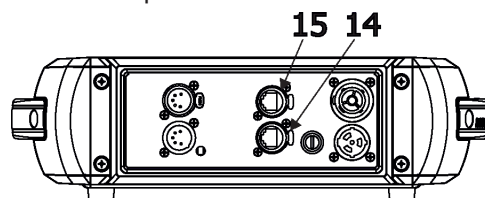

- | | |
|---------------------|---|
| 1- Moving head | 8 - Tilt lock |
| 2 - Yoke | 9 - DMX OUT (5-pin XLR) |
| 3 - Base | 10 - DMX IN (5-pin XLR) |
| 4 - Handle | 11 - Fuse holder |
| 5 - Touch screen | 12 - Mains IN (Neutrik powerCON TRUE1) |
| 6 - Control buttons | 13 - Mains OUT (Neutrik powerCON TRUE1) |
| 7 - Pan lock | 14 - Ethernet IN (RJ 45) - EP version only |
| | 15 - Ethernet OUT (RJ 45) - EP version only |

The head has to be locked for transportation - the pan lock latch (7) and the tilt lock latch (8) have to be in the locked positions. To unlock the head, move these latches to unlock positions before operating the fixture.

3. Installation



Fixtures must be installed by a qualified electrician in accordance with all national and local electrical and construction codes and regulations.

3.1 Connection to the mains

For protection from electric shock, the fixture must be earthed!

The Robin Painte is equipped with auto-switching power supply that automatically adjusts to any 50-60Hz AC power source from 100-240 Volts.

If you need to install a power plug on the power cable to allow connection to power outlets, install a grounding-type (earthed) plug following the plug manufacturer's instructions. If you have any doubts about proper installation, consult a qualified electrician.

Core (EU)	Core (US)	Connection	Plug Terminal Marking
Brown	Black	Live	L
Light blue	White	Neutral	N
Yellow/Green	Green	Earth	

This device falls under class one and must be earthed (grounded)!

Design of the ROBIN Painte allows you to connect several fixtures to AC mains power in one interconnected chain using power input and throughput connectors. Needed daisy chain cords are stated in the chapter "Technical specifications"

Maximum number of linked fixtures depends on input voltage:

CE:

7 fixtures at power supply= 230V

6 fixtures at power supply= 208V

4 fixtures at power supply= 120V

US:

5 fixtures at power supply= 230V

5 fixtures at power supply= 208V

3 fixtures at power supply= 120V

Real numbers of fixtures may differ from values stated above as you have to take into account the length of supply cables, circuit breaker etc. at projecting of the fixtures installation Do not overload the supply line and connecting leads.

!

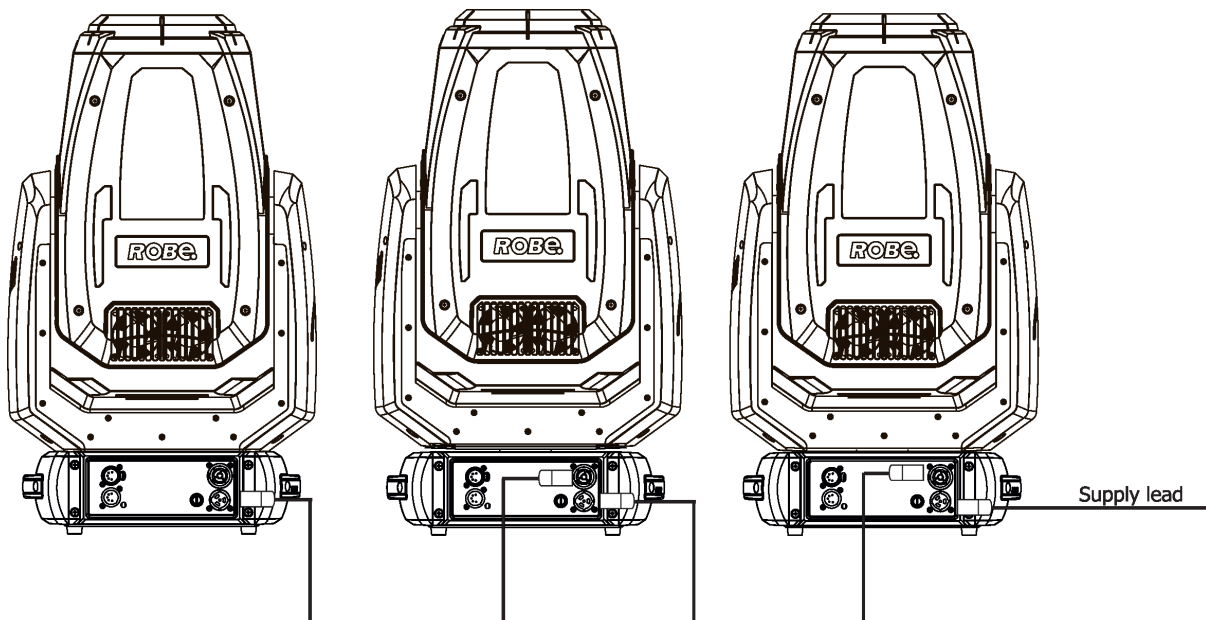

3.2 Rigging the fixture

A structure intended for installation of the fixture (s) must safely hold weight of the fixture(s) placed on it. The structure has to be certificated to the purpose.

The fixture (fixtures) must be installed in accordance with national and local electrical and construction codes and regulations.

For overhead installation, the fixture must be always secured with a safety wire that can bear at least 10 times the weight of the fixture.

When rigging, de-rigging or servicing the fixture staying in the area below the installation place, on bridges, under high working places and other endangered areas is forbidden.

The operator has to make sure that safety-relating and machine-technical installations are approved by a skilled person once a year.

The fixture should be installed outside areas where persons may walk by or be seated.

IMPORTANT! OVERHEAD RIGGING REQUIRES EXTENSIVE EXPERIENCE, including (but not limited to) calculating working load limits, installation material being used, and periodic safety inspection of all installation materials and the fixture. If you lack these qualifications, do not attempt the installation yourself, but instead use a professional structural rigger. Improper installation can result in bodily injury or damage to property. The fixture has to be installed out of the reach of people.

The fixture must never be fixed swinging freely in the room.

Caution: Fixture may cause severe injuries when crashing down! If you have doubts concerning the safety of a possible installation, do not install the moving head!

Before rigging make sure that the installation area can hold a minimum point load of 10 times the fixture's weight.

When installing the device, make sure there is no highly inflammable material (decoration articles, etc.) in a distance of min. 0.4 m.

CAUTION!
Use an appropriate clamps to rig the fixture on the truss.
Make sure that the device is fixed properly! Ensure that the structure (truss) to which you are attaching the fixture is secure.

The fixture can be placed directly on the stage floor or rigged in any orientation on a truss without altering its operation characteristics .

For securing the fixture to the truss, install a safety wire which can hold at least 10 times the weight of the fixture. Use only the safety wire with a snap hook with screw lock gate.

Truss installation

1. Bolt each clamp (1) to the omega holder (2) with M12 bolt and lock nut through the hole in the holder.
2. Fasten the omega holders to the bottom of the base by inserting both quick-lock fasteners (1) into the holes of the base and tighten fully clockwise.
3. Clamp the fixture on a truss (3) and tighten the rigging clamps.
4. Pull a safety wire (5) through the carrying handle and the truss (3) as shown on the picture above in a suitable position so that the maximum fall of the fixture will be 20 cm. Fasten a snap hook in the attachment point (6). Use only the safety wire with snap hooks with screw lock gates.

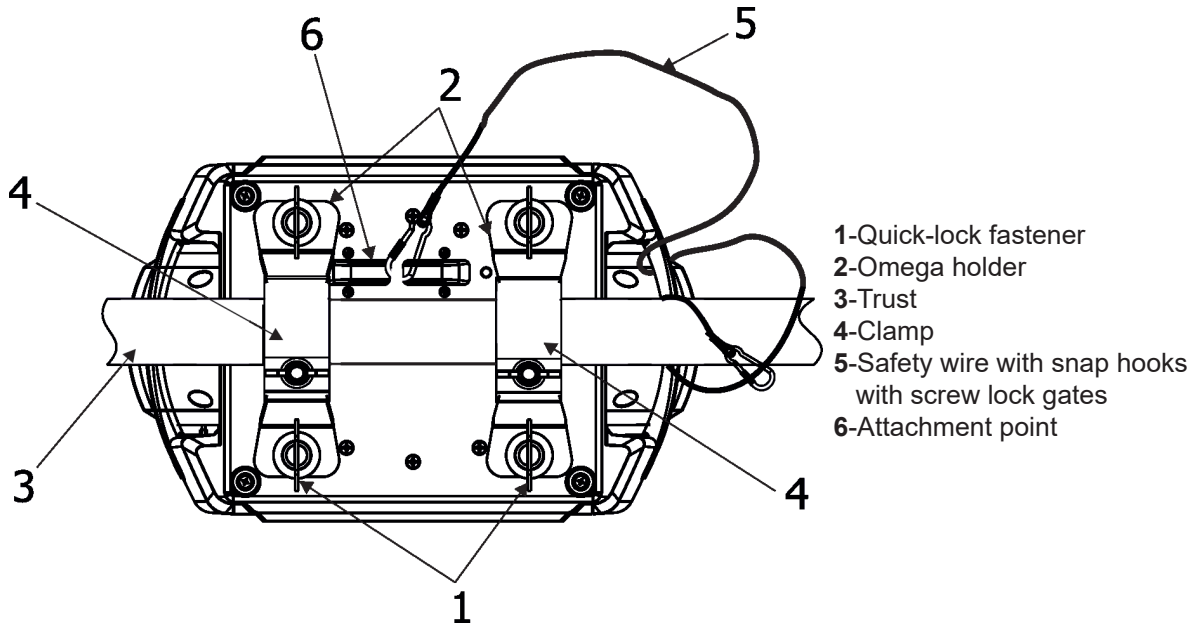

When installing fixtures side-by-side, avoid illuminating one fixture with another!

3.3 DMX-512 connection

The fixture is equipped with 5-pin XLR sockets for DMX input and output. Only use a shielded twisted-pair cable designed for RS-485 and 5-pin XLR-plugs and connectors in order to connect the controller with the fixture or one fixture with another.

DMX output

XLR socket:

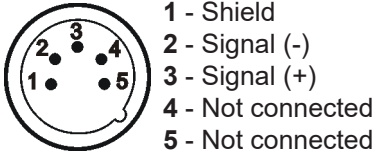

DMX input

XLR plug:

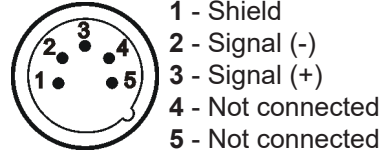

If you are using the standard DMX controller, you can connect the DMX output of the controller directly with the DMX input of the first fixture in the DMX chain. If you wish to connect DMX controllers with other XLR output, you need to use adaptor cables.

Building a serial DMX-chain.

Connect the DMX output of the first fixture in the DMX chain with the DMX input of the next fixture. Always connect one output with the input of the next fixture until all fixtures are connected. Up to 32 fixtures can be interconnected.

Caution: At the last fixture, the DMX cable has to be terminated with a terminator. Solder a 120 Ω resistor between Signal (-) and Signal (+) into a (5-pin) XLR plug and plug it in the DMX output of the last fixture

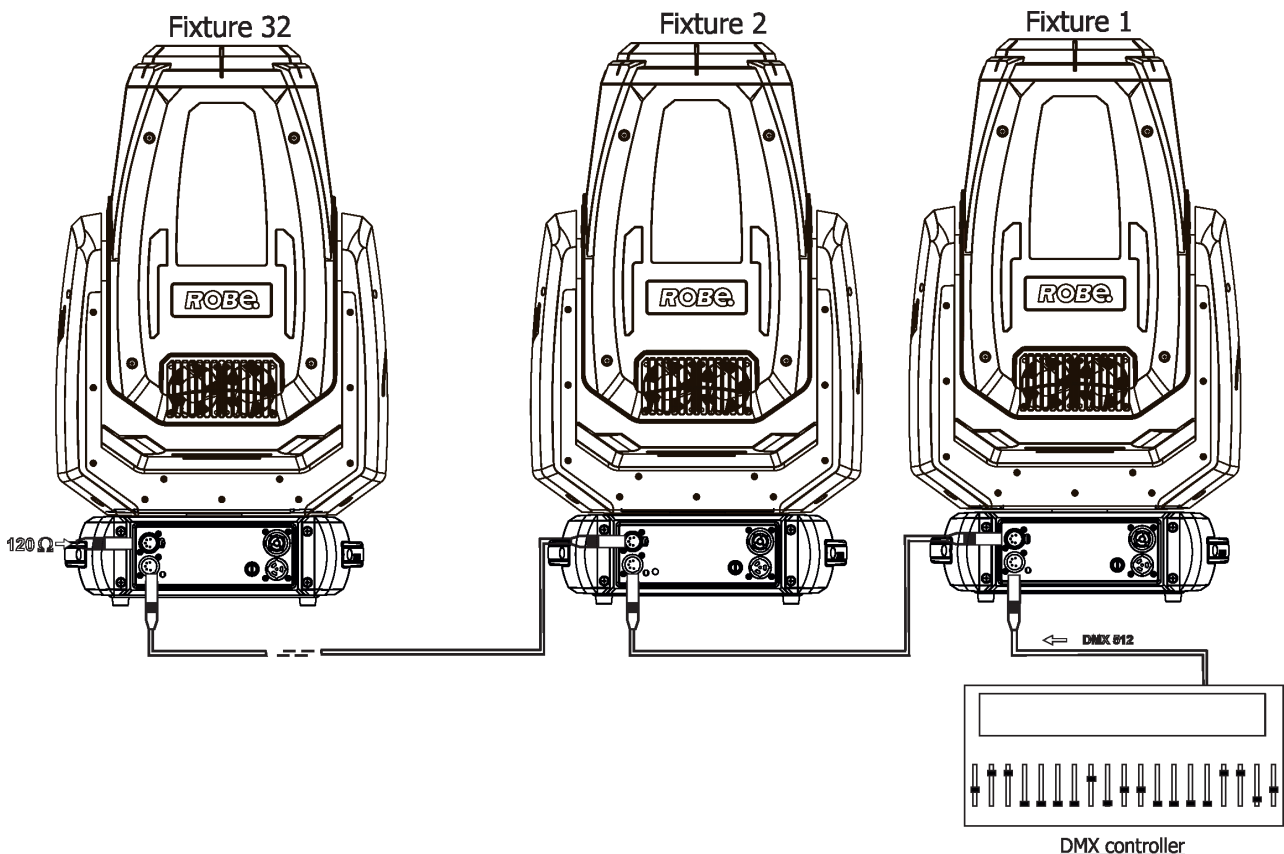

3.4 Ethernet connection

The fixtures on a data link are connected to the Ethernet with appropriate communication protocol (e.g. Art-Net). The control software running on your PC (or light console) has to support this communication protocol. Art-Net communication protocol is a 10 Base T Ethernet protocol based on the TCP/IP. Its purpose is to allow transfer of large amounts of DMX 512 data over a wide area using standard network technology.

The IP address is the Internet protocol address. The IP uniquely identifies any node (fixture) on a network.
The Universe is a single DMX 512 frame of 512 channels.

The Robin Painte is equipped with 8-pin RJ-45 sockets for Ethernet connection. Use a network cable category 5 (with four "twisted" wire pairs) and standard RJ-45 plugs in order to connect the fixture to the network.

RJ-45 socket (front view):

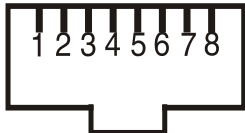

- 1- TD+
- 2- TD-
- 3- RX+
- 4- Not connected

RJ-45 plug (front view):

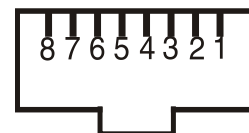

- 5- Not connected
- 6- RX-
- 7- Not connected
- 8- Not connected

Patch cables that connect fixtures to the hubs or LAN sockets are wired 1:1, that is, pins with the same numbers are connected together:

- 1-1 2-2 3-3 4-4 5-5 6-6 7-7 8-8

If only the fixture and the computer are to be interconnected, no hubs or other active components are needed. A cross-cable has to be used:

- 1-3 2-6 3-1 4-8 5-7 6-2 7-5 8-4

Connect the Ethernet inputs of all fixtures to the Ethernet network. Set their IP addresses and Net Masks. Correct communication protocol (e.g. "ArtNet") has to be selected from the menu "Ethernet Mode" in the fixtures (Addressing-->Ethernet -->Ethernet Mode). Set Universe(s) according to communication protocol.

Example of connection:

(DMX address=174)
 IP address=002.168.002.008
 Universe=1

(DMX address=88)
 IP address=002.168.002.004
 Universe=1

(DMX address=45)
 IP address=002.168.002.003
 Universe=1

(DMX address=1)
 IP address=002.168.002.002
 Universe=1

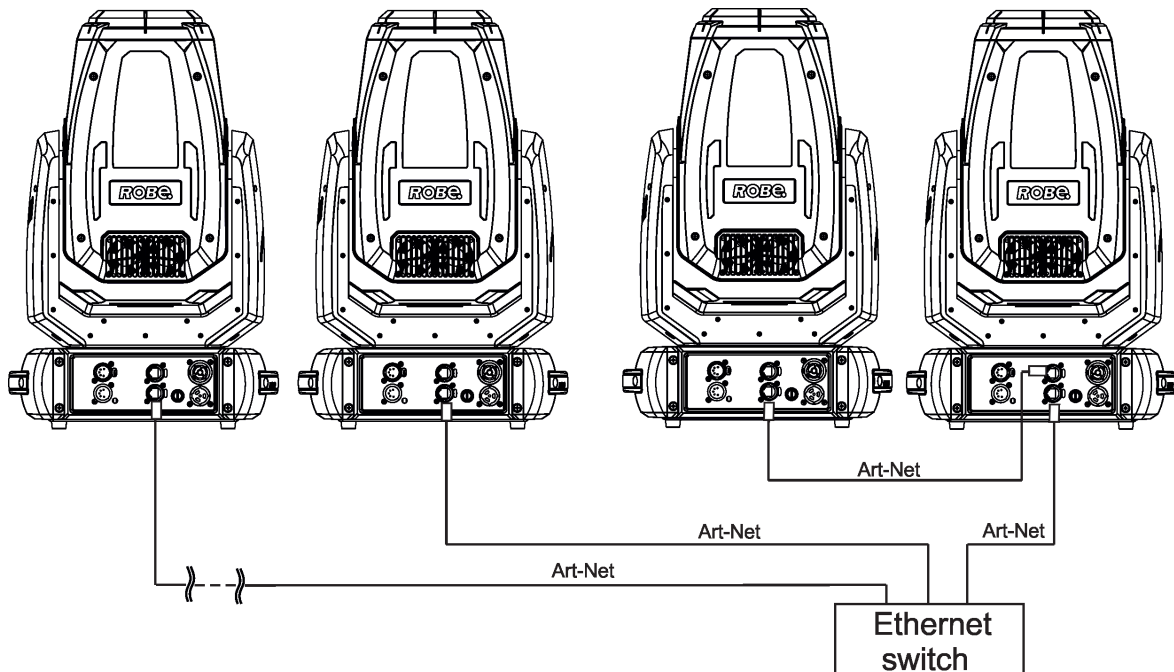

An advised PC setting: IP address: 002.xxx.xxx.xxx (Different from fixtures IP addresses)
 NET mask: 255.0.0.0

The EP version of the fixture is equipped with Ethernet Pass Through Switch which sustains Ethernet integrity, when the fixture has no power, it automatically maintains network connectivity.

If you use the Ethernet IN-OUT way for the Ethernet connection, max. 8 fixtures can be connected in the IN-OUT line.

3.5. Wireless DMX operation

The wireless version of the fixture is equipped with the Lumen Radio CRMX module and antenna for receiving DMX signal. CRMX module operates on the 2.4 GHz band.

The item " Wireless " from the menu "DMX Input" allows you to activate receiving of wireless DMX (Personality--> DMX Input -->Wireless.). First two options from the "DMX Input" menu are stated in DMX chart as well (channel Power/Special functions , range of 16-19 DMX). If DMX input option is changed by DMX command, the change is permanently written into fixture's memory.

DMX range of 16-19 switching fixture to the wired/wireless operation is active only during first 10 seconds after switching the fixture on.

After switching the fixture on, the fixture checks both modes of receiving DMX in the following order:

1. For the first five seconds, the fixture receives DMX signal from the wired input. If the Power/Special functions channel is set at some DMX input option, the fixture will receive DMX value according to this option. If DMX input option is set to the wired input , this option is saved and checking procedure is finished. If DMX input option is not set, the fixture continues next 5 seconds in scanning wireless DMX signal-see point 2.

2. For the next 5 seconds the fixture receives wireless DMX signal and again detects if the Power/Special functions channel is set at some DMX input option, if not, the fixture will take option which is set in the fixture menu "DMX Input".

To link the fixture with DMX transmitter.

The fixture can be only linked with the transmitter by running the link procedure at DMX transmitter .

After linking, the level of DMX signal (0-100 %) is displayed in the menu item "Wireless State" (Information -->Wireless State).

To unlink the fixture from DMX transmitter.

The fixture can be unlinked from transmitter via the menu item " Unlink Wireless Adapter" (Information--> Wireless State --> Unlink Wireless Adapter).

Example of connection:

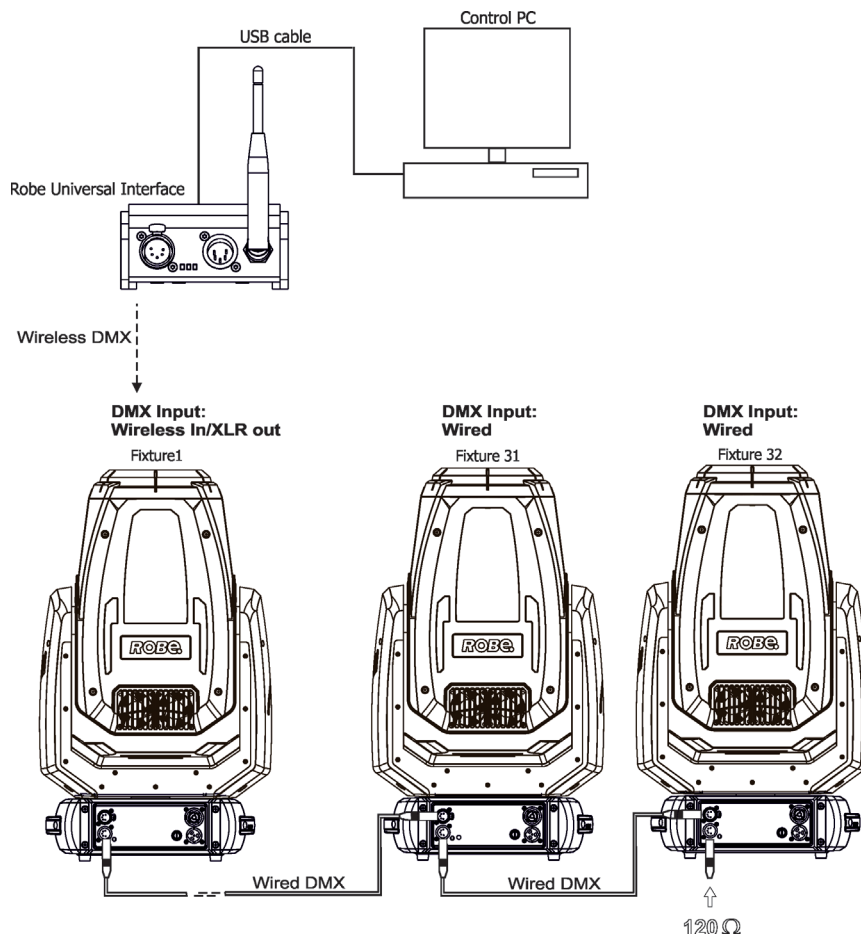

3.6. Replacing rotating gobos

Disconnect the fixture from mains before gobo replacing.

1. Disconnect the fixture from mains and allow it to cool.
2. Remove the plastic cover of the head by loosening the 4 quarter-turn fasteners on the cover.
3. Gently pull up the gobo holder from the rotation gobo wheel.
4. Carefully remove the spring gobo-lock and gobo from the gobo holder. Do not touch the surface of the pattern of the glass gobo - use a suitable glove. Be careful! Glass gobo!
5. Insert the new gobo (glazy side towards the LED source). Insert the spring-gobo lock to secure it in the gobo holder.
6. Insert the gobo holder back into rotating gobo wheel.
7. Replace the head cover before applying power.

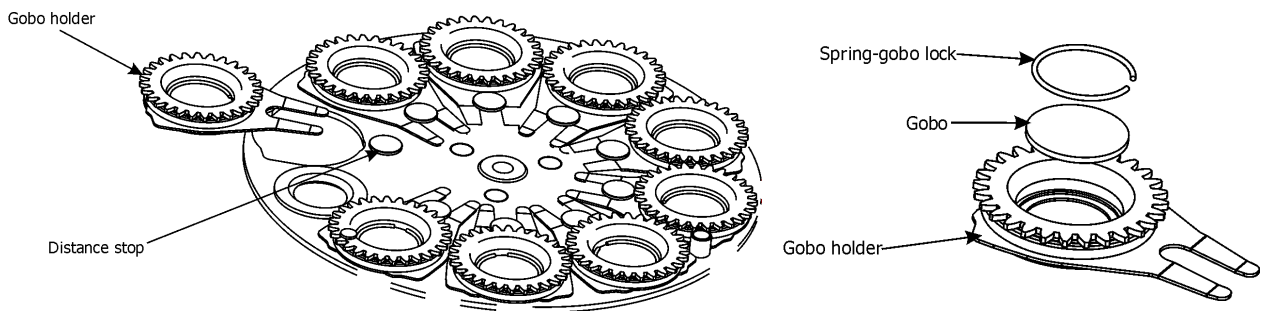

4. Remotely controllable functions

Colour wheel

The colour wheel with 9 dichroic filters rotates in both directions with variable speed which creates wide spectrum of graphic effects.

CMY colour mixing system

The CMY color mixing system is based on graduated cyan, magenta, and yellow colour filters. A continuous range of colors may be achieved by varying the amount of each filter from 0 to 100%.

Rotating gobo wheel

The rotating gobo wheel includes 8 glass gobos rotating in both directions, indexable, replaceable "SLOT&LOCK" system.

Static gobo wheel

The static gobo wheel includes 9 metal gobos. Gobo positioning and continual gobo positioning is available as well as a gobo-shake function.

Prism

The 8-facet radial prism rotates in both directions at different speeds.

Frost filter

The 5°frost filter provides variable frost for fine frosting.

Focus/Zoom

Motorized focus allows to focus beam from approx. 2 meters to infinity. Zoom range 8° - 48°.

Dimmer/Shutter unit

Smooth 0 - 100 % dimming is provided by the electronic control unit. This unit is also used for strobe effects with variable speed.

Pan/Tilt

Pan/tilt movement range: 540°/270°. Built-in electronic motion stabilizer (EMS) which ensures precise position of the fixture's head during its movement and reduces its swinging when the truss shakes.

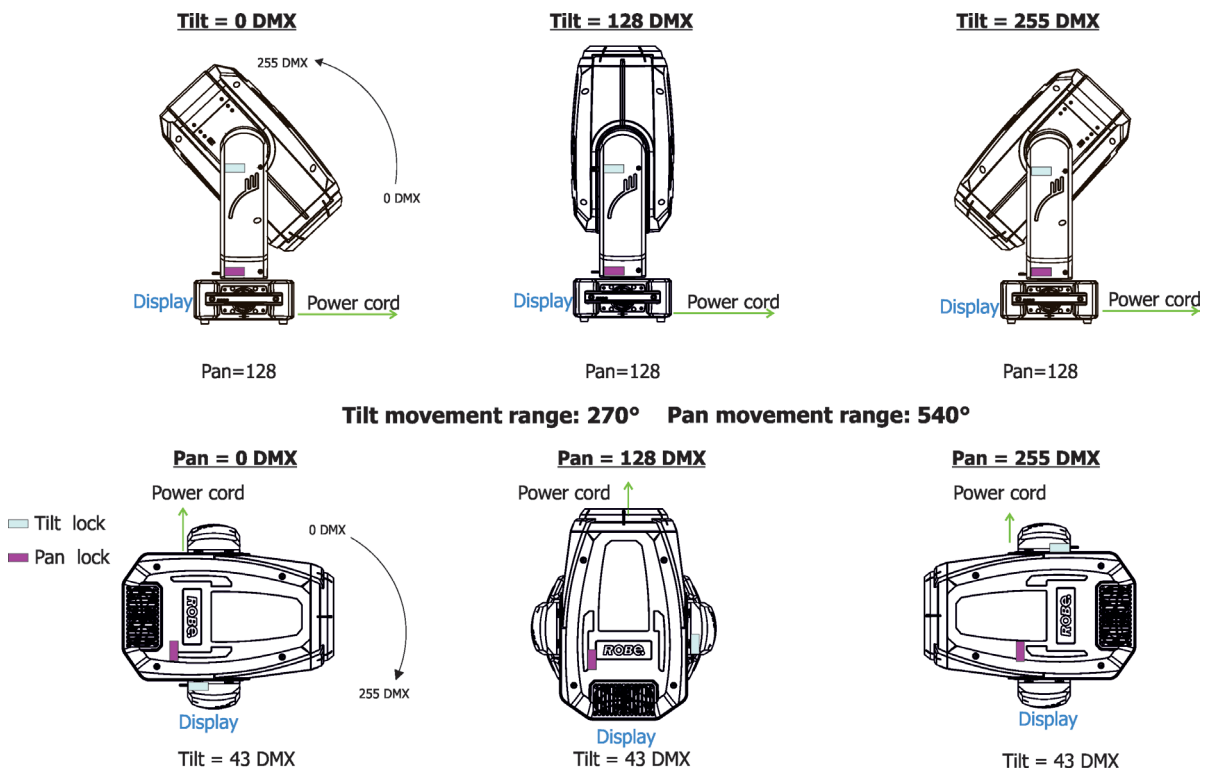

Framing system

Framing system consists of four framing shutters. There is individual control of each shutter blade position and angle, together with rotation of the complete framing module. As well as providing a sharp precise or soft frame for the projected image.

Framing system orientation:

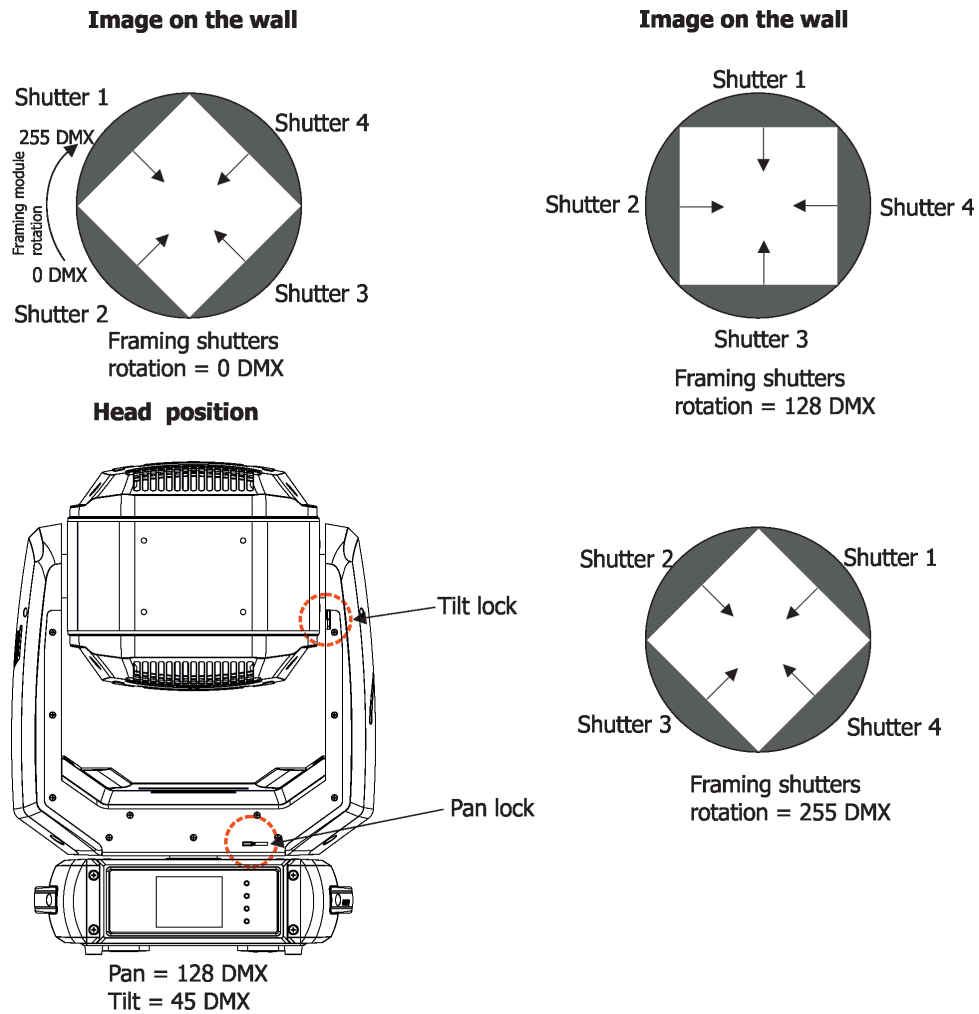



5. Control menu map

Default settings=**Bold print**

Tab	Level 1	Level 2	Level 3	Level 4	Level 5	Level 6	
Addressing	Settings	DMX Address	001-512				
		DMX Preset channels	Pan				
			:				
				Dimmer Fine			
			Ethernet Settings	Ethernet Mode	Disable		
					ArtNet		
					gMA1		
					gMA2		
					sACN		
				Ethernet To DMX	Off , On		
				IP Address/Net Mask	Default IP Address		
					Custom IP Address		
					Net Mask		
				ArtNet Universe	0-255		
				MANet settings	MANet/II Universe	01-256	
					MANet Session ID	01-32	
				sACN Settings	sACN Universe	00001-32000	
	Information	Fixture Times	Power On Time	Total Hours			
				Resetable Hours			
		Air Filters	Elapsed Time				
			Alert Period	10-300			
		Fixture Temperatures	LEDs Temperatures	Current			
				Maximum NonRes..			
				Maximum Res..			
			Driver Temperature	Current			
				Maximum NonRes..			
				Maximum Res..			
			Base Temperature	Current			
				Maximum NonRes.			
				Maximum Res.			
		DMX Values	Pan				
			:				
			Dimmer Fine				
		Wireless State	Signal Quality				
			Unlink Wireless Adapter				
		Power Channel state					
		Software Version	Display System				
			Module M				
		Module L					
		Module O					
		Module F-A					
		Module F-B					
		Module G					
		Module C					
	Product IDs	Mac Address					
		RDM UID					
		RDM Label					
	LED Module info	First Module Assembly					

Tab	Level 1	Level 2	Level 3	Level 4	Level 5	Level 6
		Actual Module Info				
		Assembly History				
		Intensity History				
	LED Modules History					
	View Logs	Fixture Errors				
		Fixture States	Power On			
			Power Off			
		Fixture Position				
		Fixture Temperatures	LEDs Temperature			
			Driver Temperatures			
			Base Temperatures			
Personality	User Mode	User A Settings				
		User B Settings				
	DMX Preset channels	Pan				
		:				
		Dimmer Fine				
	DMX Input	Wired				
		Wireless				
		Wireless In/XLR Out				
	Pan/Tilt Settings	Pan Reverse	Off, On			
		Tilt Reverse	Off, On			
		Pan/Tilt Feedback	Off, On			
		Pan/Tilt mode	Time			
			Speed			
	Pan/Tilt Reset	With P/T				
		Without P/T				
		Tilt, then Pan				
		Pan, then Tilt				
	Pan/Tilt EMS	Off, On				
	Microphone Sensitivity	1-10-20				
	Blackout Settings	Blackout During M.C.	Off, On			
		Blackout while:	Pan/Tilt moving	Off, On		
			Colour Wheel Moving	Off, On		
	Frequency Setup	300 Hz				
		600Hz				
		1200Hz				
		2400Hz				
		High				
		Frequency Adjust				
	Init Effect Positions	Pan	0-255			
		:				
		Dimmer Fine	0-255			
	Screen Settings	Display Intensity	1-10			
		Screen Saver Delay	Off-10min.			
		Touchscreen Lock	Off-10min.			
		Recalibrate Touchscreen				
		Display Orientation	Normal			
			Inverted			
			Auto			
	Temperature Unit	°C, °F				
	Fan Settings	Fan mode	Auto			
			High			
			Quiet			
		Quiet - Blackout Fan Off	On, Off			

Tab	Level 1	Level 2	Level 3	Level 4	Level 5	Level 6
	Dimmer Curve	Linear				
		Square Law				
		Super Square Law				
	Gobo Indexing	Max. Speed & ShortCut				
		Follow Speed & Direction				
		Max. Speed & Follow Dir.				
	Date & Time Settings					
	Focus Tracking	Off, On				
	Default Settings					
	Password Protection	Off, On				
	Reset Web Password					
Manual Control	Reset Functions	Total System Reset				
		Pan/Tilt reset				
		System Reset w/o P/T				
		Pan Reset				
		Tilt Reset				
		Color System Reset				
		Gobo/Eff. Wh. Reset				
		Optics/Prism/Frost Res.				
		Iris/framing Sh. Reset				
	Manual Effect Control	Pan	0-255			
		:				
		Dimmer Fine	0-255			
Stand -Alone	Test Sequences	Dynamic Mode				
		Static Mode	Pan	0-255		
			Tilt	0-255		
			Zoom	0-255		
			Focus	0-255		
	MusicTrigger	Off, On				
	Preset Playback	None				
		Test				
		Prog. 1				
		Prog. 2				
	Play Program	Play Program 1				
		Play Program 2				
	Edit Program	Edit Program 1	Start Step	1-80		
		Edit Program 2	End Step	1-80		
			Edit Program Steps	Step 1	Pan	0-255
				:	:	
				:	Dimmer Fine	0-255
				:	Step Time	0-25,5 sec.
				Step 80	Pan	0-255
					:	
					Dimmer Fine	0-255
					Step Time	0-25,5 sec.
Service	Adjust DMX Values	Pan	0-255			
		:				
		Dimmer Fine	0-255			
	Calibrations	Calibrate Effects	Pan	0-255		
			Tilt	0-255		
			Rot. Gobo Wheel	0-255		
			R. Gobo Index 1	0-255		
			:	:		

Tab	Level 1	Level 2	Level 3	Level 4	Level 5	Level 6
			R. Gobo Index 8	0-255		
			Static Gobo	0-255		
			Colour Wheel	0-255		
			Cyan	0-255		
			Magenta	0-255		
			Yellow	0-255		
			Prism 1	0-255		
			Prism 2	0-255		
			Prism Rotation	0-255		
			Zoom	0-255		
			Focus	0-255		
			Iris	0-255		
			Frost 1	0-255		
			Frost 2	0-255		
			Fr. Shutters rot.	0-255		
			Fr. Shutter 1 Move	0-255		
			Fr. Shutter 1 Swiv	0-255		
			Fr. Shutter 2 Move	0-255		
			Fr. Shutter 2 Swiv	0-255		
			Fr. Shutter 3 Move	0-255		
			Fr. Shutter 3 Swiv	0-255		
			Fr. Shutter 4 Move	0-255		
			Fr. Shutter 4 Swiv	0-255		
		Calibrate Fr. Hysteresis	Framing Lamella 1	0-8		
			Framing Lamella 2	0-8		
			Framing Lamella 3	0-8		
			Framing Lamella 4	0-8		
		Calibrate Pan/Tilt EMS				
		Load Default Calibrations				
	Rotating Gobos Change	Gobo Carousel 1	G1-Mg			
			G2			
			:			
			G8			
			Gobo Offset	0-255		
	LEDs Measure					
	Update Software					

6. Control menu

The Robin Forte is equipped with the QVGA Robe touch screen with battery backup which allows you to set the fixture's behaviour according to your needs, obtain information on its operation, control all range of effects and program it in stand-alone mode.

The fixture's menu can be controlled either by the control buttons or directly by touching the icon.

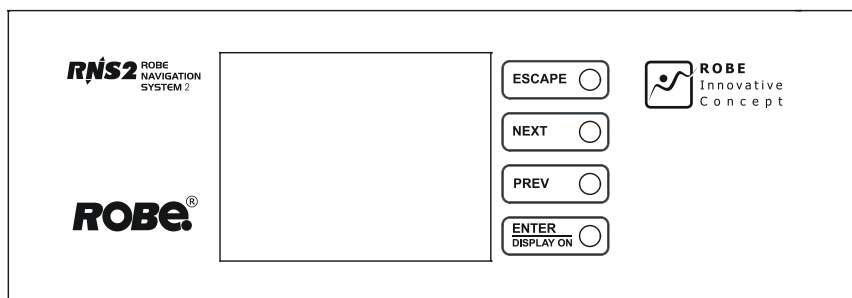

Control buttons on the front panel













[ESCAPE] button used to leave the menu without saving changes.

[NEXT] , [PREV] buttons for moving between menu items and symbols, adjusting values.

[ENTER/Display On] button used to enter the selected menu (menu item) and to confirm adjusted value.

If the fixture is disconnected from mains, the button switches the touch screen on.

Icons used in the touch screen menu:

-  - [back arrow] used to move back to the previous screen (menu).
-  - [up arrow] used to move up on the previous page.
-  - [down arrow] used to move down on the next page.
-  - [confirm] used to save adjusted values, to leave menu or to perform desired action.
-  - [cancel] used to leave menu item without saving changes.
-  - [confirm+copy] used to save adjusted values and copy them to the next prog. step.
-  - [warning icon] used to indicate some error which has occurred in the fixture.
-  - [Ethernet] used to indicate Ethernet connected.
-  - [menu rotation] used to rotate menu 180 degrees from current orientation.
-  - [slider control] used to recall slider system for setting desired value.
-  - [keyboard control] used to recall keyboard system for setting desired value.
-  - [air filters cleaning] used to signal that cleaning period of the air filters elapsed.

After switching the fixture on, the touch screen shows the screen with the ROBE logo. Type of used LED engine in the fixture is displayed on the bottom line of the screen:



HP - High Performance Engine for maximum light output and optimal colour characteristics.

HCF - High Colour Fidelity Engine for the best light quality and colour reproduction.

The type of used LED engine is displayed if the fixture is disconnected from power as well.

Touch any part of the screen or press the [ENTER/Display On] button to display the initial screen with the current stored DMX address:

Note: The green icon at the top right corner of the screen indicates the level of the display battery charging. If the whole icon is green, the battery is fully charged while the red icon indicates exhausted battery. The battery charges during fixture operation, its charging lasts cca 6 hours.

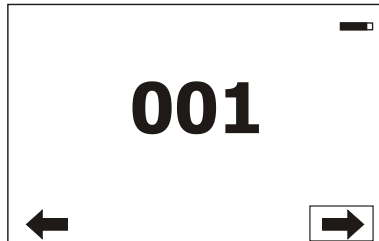

We recommend that the fixture should be in operation at least 7 hours per week to keep the battery fully charged. If you switch the fixture on and this screen will not appear till 1 minute, switch the fixture off and on again. If the screen lights, the battery is exhausted. In case the screen still does not light, the battery is faulty.

This is also indicated by an error message "Faulty battery" and if such an error message appears the battery should be replaced immediately. The lifetime of the battery is highly dependent on ambient temperature (and consequently on base temperature). If the maximum ambient temperatures (as recorded and displayed in menu: Information -> Fixture Temperatures -> Ambient Temperature -> Maximum NonRes.) are kept within the specified limits, the battery should last for at least two years. Should the ambient temperatures exceed the specified maximum temperature, the lifetime of the batteries could be considerably shortened even up to just one year or less and also result in physical damage (battery leakage) or unreliable fixture functions.

Damage caused by batteries failed due to exceeded maximum ambient temperature cannot be claimed under warranty terms.

Touch the green arrow at the bottom right corner of the screen or press the [ENTER/Display On] button to enter the "Address" menu.

Each item (such as a Tab, menu item, text box, icon) may be selected from a screen by simply touching the item in the list or by pressing the [NEXT] or [PREV] buttons to scroll through list items. With each press, the next item is highlighted. Press [ENTER/Display On] to select the highlighted item.

Before first fixture operation, set current date and time in the menu "Date & Time Settings" (menu path: Personality--> Date & Time Settings).

6.1 Tab "Address"



DMX Address - Select the menu to set the DMX start address.

DMX Preset channels - The menu item offers you an overview of 44 control channels.

Ethernet Settings* - The menu allows all needed settings for the Ethernet operation

Ethernet Mode

Disable - The option disables Ethernet operation.

Artnet - Fixture receives Artnet protocol

gMAI - Fixture receives MANet 1 protocol

gMA2 - Fixture receives MANet 2 protocol

sACN - Fixture receives sACN protocol

Ethernet To DMX - Fixture receives protocol from the Ethernet input and sends DMX data to its DMX output (fixture works as an "Ethernet/DMX converter", next fixture can be connected to its DMX output and you can build a standard DMX chain by connecting another fixtures. Only one fixture has to be connected to the Ethernet.

IP Address/Net Mask - Select this menu to set IP address. IP address is the Internet protocol address. The IP uniquely identifies any node (fixture) on a network.

There cannot be 2 fixtures with the same IP address on the network!

Default IP Address -Preset IP address, you can set up only first byte of IP address (2 or 10) e.g. **002**.019.052.086.

Custom IP Address - The option enables to set up all bytes of IP address.

Net Mask - The option enables to set up all bytes of Net Mask.

ArtNet Universe - Use this item to set a Universe (0-255). The Universe is a single DMX 512 frame of 512 channels.

MANet Settings - Use this menu to set parameters for MANet operation.

MANet Universe I/II - The value of this item can be set in range 1-256.

MANet Session ID - The value of this item can be set in range 1-32.

sACN Settings - Use this menu to set parameters for sACN operation.

sACN Universe - The value of this item can be set in range 1-32000.

6.2 Tab "Information"



Fixture Times - The menu provides readouts of fixture and LED module operation hours.

Power On Time Hours - Select this menu to read the number of fixture operation hours.

Total Hours - The item shows the total number of the operation hours since the Robin Forte has been fabricated.

Resetable Hours - The item shows the number of the operation hours that the Robin Forte has been powered on since the counter was last reset.

In order to reset this counter to 0, touch the text box next to the item "Resetable Hours:"

LED On Time - Select this menu to read the number of LEDs operation hours.

Total Hours - a total time of the LEDs module operation during which a dimmer intensity was > 0%.

Adaptive Hours - a relative time of the LEDs module operation during which a dimmer intensity was > 0%. (e.g. if dimmer = 20% for one hour, the adaptive time is 0.2 hour, if dimmer = 100% for one hour, the adaptive time is 1 hour).

Air Filters - Regular cleaning of the air filters is very important for the fixture's life and performance.

Bild-up of dust, dirt and fog fluid residues reduces the fixture's light output and cooling ability.

The two items of this menu help you to keep cleaning period of the air filters.

Alert period - Cleaning schedule for the fixture depends on the operating environment.

It is therefore impossible to specify accurate cleaning interval. This item allows you to change the cleaning interval of the air filters. This "alert" value is 300 hours and it is set as default. Inspect the fixture within its 300 hours of operation to see whether cleaning is necessary. If cleaning is required, clean all air filters and change the value in this menu on acceptable level. Min. level of alert period is 10 hours, max. is 300 hours.

Elapsed Time - The item allows you to read the time which remains to cleaning air filters.

The time period is set in the menu mentioned above.

Expired time period is signalled by a negative mark (-) at the time value and a warning icon on the display.

Clean the filters and reset this menu item (by touching the text box next to the item "Elapsed Time").

Fixture Temperatures - The menu is used to view temperatures of the fixture's inside.

LEDs temperature - The menu shows temperature on the LED PCB in the light source

Current - A current temperature of the LED PCB.

Maximum NonRes. - A maximum temperature of the LED PCB since the fixture has been fabricated.

Maximum Res. - A maximum temperature of the LED PCBs since the counter was last reset.

In order to reset some counter to 0, touch desired text box under item "Max.Res."

Driver Temperature - The menu shows temperature on the LEDs control PCB in the fixture head.

Current - A current temperature on the LEDs control PCB.

Maximum NonRes. - A maximum temperature on the LEDs control PCB since the fixture has been fabricated.

Maximum Res. - A maximum temperature on the LEDs control PCB since the counter was last reset.

In order to reset this counter to 0, touch the text box next to the item "Maximum Res."

Ambient Temperature - The menu shows temperature in the fixture base .

Current - A current temperature in the fixture base.

Maximum NonRes. - A maximum temperature in the fixture base since the fixture has been fabricated.

Maximum Res. - A maximum temperature in the fixture base since the counter was last reset.

In order to reset this counter to 0, touch the text box next to the item "Maximum Res."

Base Temperature - The menu shows temperature on the display PCB in the fixture base.

Current - A current temperature on the display PCB.

Maximum NonRes. - A maximum temperature on the display PCB since the fixture has been fabricated.

Maximum Res. - A maximum temperature on the display PCB since the counter was last reset.

In order to reset this counter to 0, touch the text box next to the item "Maximum Res."

DMX Values - The menu items allows you to read DMX values of each channel received by the fixture.

Wireless State - The menu serves for reading of the wireless operation status.

Unlink Wireless Adaptor - The item serves for unlinking the fixture from a DMX transmitter.

If the wireless module is not installed in the fixture, message" Wireless Module Not Installed" will appear.

Power Channel State - Select this item to see current setting of the functions, which can be set by menu items in "Personality" as well as by DMX command at channel "Power/Special functions".

Colour Functions State - Select this item to see current setting of the colour functions, which can be set by menu items in "Personality" as well as by DMX command at channel "Colour functions".

Software Version - Select this item to read the software version of the fixture processors:

Display System - A display processor on the display board in the fixture base

Module M - a Pan/Tilt processor

Module L - a LEDs control processor

Module O - a Focus/zoom/frost control processor

Module F-A -a Framming shutters control processor

Module F-B - a Framming shutters/Iris control processor

Module G - a Rot. gobo/static gobo wheel control processor

Module C - a Colour wheel and CMY control processor

Product IDs - The menu is used to read the MAC Address ,RDM UID and RDM Label.

LED Module Info - Use this menu to read LEDs module information.

First Module Assembly - Use the item to read initial information about the LEDs module installed in the fixture. The fixture has to be connected to mains to read the values in the menu items.

Serial Number/ Device UID - a serial number of the LEDs module/RDM UID of the fixture.

Installation Date/Time - a date/time of the first installation of the LEDs module to a some Forte device.

Intensity - an original intensity of the LEDs module in percentages (100%).

LEDs On Time Total/Adaptive - Total: a total time of the LEDs module operation during which the dimmer intensity was > 0%.

Adaptive: a relative time of the LEDs module operation during which the dimmer intensity

was > 0% (e.g. if dimmer = 50% for one hour, the adaptive time is 0.5 hour, if dimmer = 100% for one hour, the adaptive time is 1 hour).

Actual Module Info - Use the item to read current information about the LEDs module installed in the fixture.

Serial Number/ Device UID - a serial number of the LEDs module/RDM UID of the fixture.

Measurement Date/Time - a date/time of running the procedure "LEDs Measure" in the tab Service.

Intensity - the item shows a light intensity of the LEDs module measured after running the procedure "LEDs Measure" in the tab Service. The light intensity is displayed in percentages in relation to the initial intensity of the new LEDs module (initial intensity=100%).

LEDs On Time Total/Adaptive - Total: a total time of the LEDs module operation during which the dimmer intensity was > 0%.

Adaptive: a relative time of the LEDs module operation during which the dimmer intensity was > 0% (e.g. if dimmer = 50% for one hour, the adaptive time is 0.5 hour, if dimmer = 100% for one hour, the adaptive time is 1 hour).

Assembly History - Use the item to read a history of the LEDs module installed in the fixture (its serial number, RDM UID of fixture at which was installed and date/time of installation).

Up to 31 records can be saved in the menu item.

Intensity History - Use the item to read a history of light intensity of the LEDs module installed in the fixture.

Serial Number/ Device UID - a serial number of the LEDs module/RDM UID of the fixture.

Measurement Date/Time - a date/time of running the procedure "LEDs Measure" in the tab Service.

Intensity - the item shows a light intensity of the LEDs module measured after running the procedure "LEDs Measure" in the tab Service. The light intensity is displayed in percentages in relation to the initial intensity of the new LEDs module (initial intensity=100%) .

Up to 31 records can be saved in the menu item.

LED Modules History - Use the item to read a history of the LEDs modules installed in the fixture (their serial numbers and date/time of installation).

Up to 31 records can be saved in the menu item.

View Logs - Use this menu to read fixture's data which have been recorded during fixture operation. This collected data allows easier troubleshooting.

Fixture Errors - Use this menu to read fixture errors which have occurred during fixture operation.

Fixture States - In the menu are recorded fixture states as power on and power off.

Fixture Positions - In the menu are recorded installation positions of the fixture:

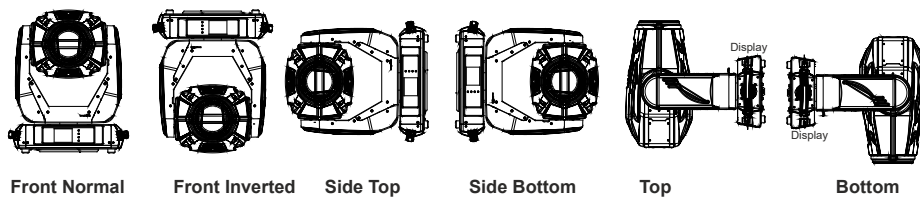

Fixture Temperatures - In the menu are recorded temperatures which have exceeded defined levels.

Note: The log buffer can contain max. 8000 records. If the buffer is full, old data will be overwritten.

6.3 Tab "Personality"



User mode - The Robin Forte allows you to recall two user settings. After switching the fixture on for the first time, the User A settings is active. Now all changes made in the "Personality" menu, "Addressing" menu and the "Music Trigger" and "Preset Playback" items from the "Stand-alone" menu are saved to the User A settings. If you now select the User B settings, from this moment the changes made in these menus will be saved to the User B settings. After switching the fixture off and on, the User B setting is active. In this way you may use the two fixture operating behaviours.

User A Settings - the function recalls the user A settings.

User B Settings - the function recalls the user B settings.

DMX Preset channels - Use the menu to display overview of control channels.

DMX Input - Use the menu to select mode of DMX signal receiving.

Wired - DMX signal is received by means of the standard DMX cable.

Wireless - DMX signal is received by means of the inbuilt wireless module.

Wireless In/XLR Out - the fixture receives wireless DMX and sends the signal to its wired DMX output.

The fixture behaves as "Wireless/Wired" adapter.

The options "Wired" and "Wireless" are also stated in DMX chart (channel Power/Special functions).

Note. If the wireless module is not installed in the fixture, the following message will appear:

DMX Input Set to Wired

Wireless Module Missing

If the fixture is not connected to mains, the message "Not Available In Offline Mode" will appear after entering the menu DMX Input. To enter this menu, the fixture has to be connected to mains.

Pan/Tilt Settings - Use the menu set behaviour of both pan and tilt movements.

Pan Reverse - The item allows to invert pan movement.

Tilt Reverse - The item allows to invert tilt movement.

Pan/Tilt Feedback - The item allows to return the moving head to the required pan/tilt position after changing the position by an external force if this option is set on.

Note. Be careful, the Pan/Tilt Feedback should be permanent On, the option Off is not suitable for standard operation and the head of the fixture can be damaged!

Pan/Tilt mode - Use this menu to set the mode of the pan/tilt movement

Time mode - The pan and tilt will move with different speeds and they will come at the same time to the end point of their tracks (pan and tilt use their optimal speeds).

Time of the pan/tilt movement (25.5 sec. max.) is set by the channel "Pan/Tilt speed, Pan/Tilt time".

Speed Mode - Both Pan and tilt will move with the same speed as adjusted at the channel "Pan/Tilt speed, Pan/Tilt time".

Pan/Tilt Reset - This menu item allows you to choose a way of pan/tilt reset after switching the fixture on

With P/T - With pan and tilt - the item will reset both pan and tilt simultaneously after switching the fixture on.

Without P/T - Without pan and tilt reset after switching the fixture on. The pan and tilt reset can be run by the menu Manual Control (Manual Control --> Reset Functions) or by DMX commands.

Tilt then Pan - the item will reset pan and tilt sequentially, first tilt, then set tilt to DMX 128 and reset pan.

Pan then Tilt - the item will reset pan and tilt sequentially, first pan, then set pan to DMX 128 and reset tilt.

Note: DMX triggered pan/tilt related reset commands on the channel Power/Special functions always behave in this way:

"Total fixture reset (including pan/tilt)" - resets all functions including pan and tilt. Pan and tilt always are reset, either simultaneously or sequentially.

"Total fixture reset (without pan/tilt)" - resets all functions except pan and tilt. When set to simultaneous reset (the standard reset With P/T), the head will position itself briefly into defined position for reset of the optical system.

"Pan and Tilt reset" - pan and tilt always are reset, either simultaneously or sequentially (depends on setting in the display menu Personality --> Pan/Tilt Reset).

"Pan reset" - resets pan, tilt is static in the position of a tilt DMX value received when pan reset was received.

"Tilt reset" - resets tilt, pan is static in the position of a pan DMX value received when tilt reset was received.

Pan/Tilt EMS - Built-in electronic motion stabilizer ensures precise position of the fixture's head during its movement and also reducing its swinging when the truss shakes.

Microphone Sensitivity - Enter the menu if you want to adjust the microphone sensitivity from 1 (max.) to 20 (min.).

Blackout Settings - Use the menu if you need to close the light output under certain conditions which are described below

Blackout During MC - Blackout during movement correction. Set this option On if you wish to close light output during the time when the head goes to its correct position from which has been changed by an external force.

Active Blackouts - Use this menu if you wish to close the light output during effect changes.

Pan/Tilt Moving - The menu item enables to close light output while the pan/tilt DMX values are changing.

Colour Wheel Moving - The menu item enables to close light output while colour wheel is moving.

Frequency Setup - The function allows you to set the PWM (Pulse Width Modulation) output frequency of LEDs to 300Hz, 600Hz, 1200Hz, 2400Hz or High.

Frequency Adjust - The menu item allows you fine adjustment of the LED frequency around selected frequency.

Init Effect Positions - Use the menu to set all effects to the desired positions at which they will stay after switching the fixture on without DMX signal received.

Screen Settings - Use this menu to change the touch screen settings.

Display Intensity - The item allows to control the intensity of the screen (1-min., 10-max.).

Screen saver Delay - The item allows you to keep the screen on or to turn it off automatically after 1-10 minutes after last touch (or pressing any button on the control panel).

Touchscreen Lock - The item allows you to lock the screen after last touch (or pressing any button on the control panel). The time delay can be set in range of 1-10 minutes. To unlock the screen, press the [ENTER/Display On] button.

Recalibrate Touchscreen - The item starts calibration of the touch screen. Follow the instructions on the screen.

Display Orientation - The menu allows to change display orientation.

Normal - Standard display orientation if the fixture is placed horizontally (e.g. on the ground).

Inverted - Inverted orientation (needed if the fixture is hanging on the truss).

Auto - The option activates a gravitation sensor for automatic screen orientation.

Note: **Auto** option is set as default. You change the display orientation by touching the icon  on the display, and the option set in the "Display Orientation" menu is temporarily overridden.

Temperature unit - Use the menu item to change temperature unit from °C to °F.

Fan Settings - Use the menu to set fans operation mode.

Fan Mode - Use the menu to set the fixture fans to max. power mode (option "**High**") or to the auto-control mode (option "**Auto**"). The third option "**Quiet**" allows you to set desired fan noise. The light output of the fixture is reduced at low speeds of fans.

Quiet - Blackout Fan Off - The menu item allows you to stop all fans in the fixture (option "**On**") when its light output is closed (shutter in range of 0-31 DMX or dimmer in 0 DMX).

Dimmer Curve - Use the menu to select desired dimmer curve: Linear, Square Law or Super Square Law.

Gobo Indexing - The following three options define transition from gobo rotation to gobo indexing.

Max. Speed & Shortcut - Gobo goes from its rotation to desired indexed position with max. speed and via shortest track.

Follow Speed & Direction - Gobo goes from its rotation to desired indexed position with current speed and keeps a direction of rotation.

Max. Speed & Follow Dir. - Gobo goes from its rotation to desired indexed position with max. speed and keeps a direction of rotation.

Date & Time Settings - Use this menu to set current date and time for the fixture log system (menu "View Logs"). Set this menu items before first fixture operation.

Focus Tracking - This feature provides automatic sharpness re-adjustment during zoom movement, after an initial sharpness has been set by the operator by setting the focus channel and enabling the FocusTracking. The Focus Tracking feature is done via automatic movement of focus element, taking into account several internal parameters, zoom position being one of them. To utilize the Focus Tracking, make sure to enable the Focus Tracking, set the Zoom to value 200 and adjust Focus to desired sharpness. Then, while keeping Focus value untouched, you can move the Zoom. Fixture will automatically keep the projection at the desired sharpness as much as possible. You can also re-adjust the Focus value over time if needed. When switching between static

gobo wheel, rotating gobo wheel and an empty aperture, the Focus Tracking will adjust the internal parameters, therefore providing desired sharpness by adjusting the Focus might be required. If you use both Static gobo wheel and rotating gobo wheel without further adjusting the Focus value, rotating gobo wheel will be automatically used for Focus Tracking 's focusing.

Default Settings - The menu item allows to set all fixture parameters in this menu to the default (factory) values except items "DMX Input".

Password Protection - allows to enter password in order to prevent unauthorized person from changing setting of the fixture.

Reset Web Password - The menu item allows you to reset a password for access on the Web server (default password: 2479, user: robe).

6.4 Tab "Manual Control"



Reset Functions - The menu allows to reset the fixture either per function modules or all modules together.

Total System Reset - The item resets all function modules.

Pan/Tilt Reset - The item resets pan and tilt.

System Reset w/o P/T - The item resets all function modules except pan/tilt

Pan Reset - The item resets a pan.

Tilt Reset - The item resets a tilt.

Colour System Reset - The item resets colour wheel 1/colour wheel 2 and CMY+CTO system.

Gobo/Eff. Wh. Reset - The item resets rotating gobo wheels and an effect wheel.

Optics/Prism/Frost Res. - The item resets a zoom, focus, prism and a frost module.

Iris/Framing Sh. Reset - The item resets an iris module and framing shutters.

Manual Effect control - Use the menu to control all fixture channels by means of the control panel.

6.5 Tab "Stand-alone"



Test Sequences -Use the menu to run a test/demo sequences without an external controller, which will show you some possibilities of using Robin Forte.

Dynamic Mode - This mode uses all Robin Forte functions including pan/tilt movement and therefore is good for a complete introduction of the fixture.

Static Mode - This mode is suitable for projections on the wall, ceiling or ground without any pan/tilt movement. Adjust the pan, tilt, zoom and focus to desired positions and start test sequences by touching the green ► icon.

Music Trigger - Use the item to activate the sound control of the running program via the built-in microphone.

Preset Playback - This menu allows you to select the program which will be played in a loop after switching the fixture on (the option is commonly used in a stand-alone operation without an external controller).

None - The option disables "Presetting playback" function.

Test - The option starts the test sequences.

Prog. 1 - The option starts user program No. 1.

Prog. 2 - The option starts user program No. 2.

Play program - Use the menu to run desired program in a loop.

Play Program 1 - The option starts user program No.1.

Play Program 2 - The option starts user program No. 2.

Edit Program - Use the menu to create or to edit desired program. The Robin Forte offers 2 free programs, each up to 80 steps.

Edit Program 1 - The option allows you to edit user program No.1.

Edit Program 2 - The option allows you to edit user program No.2.

To edit program:

1. Touch the item which you want to edit ("Edit Program 1" - "Edit Program 2").
2. Touch the item "Edit Program Steps".
3. Touch the item "Step 1".
4. From the list of effects touch desired effect and set its value. Browse through the list by touching the [up arrow] and [down arrow] and set all desired effects.

An item "Step Time" (value of 0-25.5 sec.) is the time during which effects last in the current step

5. Save adjusted effects to the current step by touching the [confirm] or save and copy them to the following step by touching the [confirm+copy]. By touching the text box "Preview" next to the current program step you can view created scene.

6. Repeat the steps 4 and 5 for next program steps.

7. After editing desired program steps, adjust the length of the program by touching the text boxes "Start Step" and "End Step".

Meaning of the icons used in the "Edit Program" menu:

↓ - moves down on the next page

✓ - saves adjusted values and leaves menu

↑ - moves up on the previous page

✓ - saves values to the current step and copy them to the following prog. step

✗ - leaves menu without saving values

6.6 Tab "Service"



Adjust DMX Values - The menu allows you to set all effects to desired positions before fine calibration of the effects .

Calibrations - This menu enables fine calibration of fixture effects and download default calibration values.

Calibrate Effects - The menu allows the fine adjustment of effects.

Pan- a pan position fine adjustment (value range: 0-255)

Tilt - a tilt position fine adjustment (value range: 0-255)

Rot. Gobo Wheel - a carousel of rotating gobos fine movement (value range: 0-255)

R. Gobo Index 1 - a fine movement of the rotating gobo 1 (value range: 0-255)

R. Gobo Index 2 - a fine movement of the rotating gobo 2 (value range: 0-255)

R. Gobo Index 3 - a fine movement of the rotating gobo 3 (value range: 0-255)

R. Gobo Index 4 - a fine movement of the rotating gobo 4 (value range: 0-255)

R. Gobo Index 5 - a fine movement of the rotating gobo 5 (value range: 0-255)

R. Gobo Index 6 - a fine movement of the rotating gobo 6 (value range: 0-255)

R. Gobo Index 7 - a fine movement of the rotating gobo 7 (value range: 0-255)

R. Gobo Index 8 - a fine movement of the rotating gobo 8 (value range: 0-255)

Static Gobo - a static gobo wheel fine movement (value range: 0-255)

Colour Wheel - a colour wheel fine movement (value range: 0-255)

Cyan - a cyan flag fine movement (value range: 0-255)

Magenta - a magenta flag fine movement (value range: 0-255)

Yellow - a yellow flag fine movement (value range: 0-255)

Prism 1 - a prism fine movement in relation to stop (value range: 0-255)

Prism 2 - a prism fine movement in relation to optic axis (value range: 0-255)

Prism Rotation - a prism fine rotation (value range: 0-255)

Zoom - a zoom module fine movement (value range: 0-255)

Focus - a focus module fine movement (value range: 0-255)

Iris - an iris fine movement (value range: 0-255)

Frost 1 - a frost fine movement in relation to stop (value range: 0-255)

Frost 2 - a frost fine position movement in relation to optic axis (value range: 0-255)

Fr. Shutters. rot- a framing shutters module fine rotation (value range: 0-255)

Fr. Shutter 1 Move - a Fram. lamella 1 fine moving

Fr. Shutter 1 Swiv. - a Fram. lamella 1 fine swivelling

Fr. Shutter 2 Move - a Fram. lamella 2 fine moving

- Fr. Shutter 2 Swiv.** - a Fram. lamella 2 fine swivelling
- Fr. Shutter 3 Move** - a Fram. lamella 3 fine moving
- Fr. Shutter 3 Swiv.** - a Fram. lamella 3 fine swivelling
- Fr. Shutter 4 Move** - a Fram. lamella 4 fine moving
- Fr. Shutter 4 Swiv.** - a Fram. lamella 4 fine swivelling

Calibration of the effects via the control board

1. Disconnect DMX controller from the fixture and enter the "Calibrate Effects" menu.
2. Use the [up arrow] and [down arrow] to find "Pan" and touch it to enter the fine effect adjustment screen.
3. Set desired value and save it by touching the [confirm].
4. Repeat steps 2 and 3 for next item.
5. After calibrating all effects, touch the [confirm] to save all adjusted values and reset the fixture.

Calibration of the effects via the DMX controller

1. Connect DMX controller to the fixture and enter the "Calibrate Effects" menu.

Calibration protocol:

Effect

Pan	channel 45
Tilt	channel 46
Rot. Gobo Wheel	channel 47
R. Gobo Index 1	channel 48
R. Gobo Index 2	channel 49
R. Gobo Index 3	channel 50
R. Gobo Index 4	channel 51
R. Gobo Index 5	channel 52
R. Gobo Index 6	channel 53
R. Gobo Index 7	channel 54
R. Gobo Index 8	channel 55
Static gobo	channel 56
Colour wheel	channel 57
Cyan	channel 58
Magenta	channel 59
Yellow	channel 60
Prism 1	channel 62
Prism 2	channel 63
Zoom	channel 64
Focus	channel 65
Iris	channel 66
Frost 1	channel 67
Frost 2	channel 68
Fr. Shutters rot.	channel 69
Fr. Shutter 1 Move	channel 70
Fr. Shutter 1 swiveling.	channel 71
Fr. Shutter 2 Move	channel 72
Fr. Shutter 2 swiveling	channel 73
Fr. Shutter 3 Move	channel 74
Fr. Shutter 3 swiveling	channel 75
Fr. Shutter 4 Move	channel 76
Fr. Shutter 4 swiveling	channel 77

Calibrate Fr. Hysteresis

Framing Lamella 1 - a framing lamella 1 reverse movement (value range: 0-8)

Framing Lamella 2 - a framing lamella 1 reverse movement (value range: 0-8)

Framing Lamella 3 - a framing lamella 1 reverse movement (value range: 0-8)

Framing Lamella 4 - a framing lamella 1 reverse movement (value range: 0-8)

The value set for every framing lamella gives a value at which the lamella reacts to its reverse movement promptly (without movement hysteresis).

Calibrate Pan/Tilt EMS - This menu item allows calibration of the pan/tilt electronic motion stabilizer.

Important: during this calibration any external force must not influence the fixture and the surface at which the fixture stands (or truss if the fixture hangs) has to be without movement, shake, strokes etc.

Load Default Calibrations - The item loads default (factory) calibration values.

Rotating Gobos Change - This menu makes changing of rotating gobos in the fixture easier.

Gobo Carousel - The menu allows movement of rotating gobos on the gobo carousel to positions suitable for their changing.

G1-Mg - a movement of the gobo 1 (gobo holder with magnet) to the changing position.

G2 - a movement of the gobo 2 to the changing position.

:

G8 - a movement of the gobo 8 to the changing position.

Gobo Offset - a gobo offset setting. The function allows fine swiveling of the gobo holder. The set value is valid for all gobos on the gobo carousel.

LEDs Measure - This menu item runs a procedure which measures a light intensity of the LEDs module installed in the fixture. This procedure takes about 1 minute (message "LEDs Module Measurement" is displayed on the screen). During the procedure the fixture does not receive DMX signal, pan/tilt go to 128 DMX, a shutter is open and a dimmer is set at max. light intensity (255 DMX). All effects are taken out from the light beam.

The measured light intensity is recorded in the item Intensity in the menu LED Module Info:

Tab Information --> LED Module Info--> Actual Module Info --> Intensity

Tab Information --> LED Module Info-->Intensity History --> Intensity

The light intensity in the menu item Intensity is displayed in percentages in relation to the initial intensity of the new LEDs module (initial intensity=100%).

The LEDs Measure procedure should be run after every change of the LED light source.

Note: The fixture has to be connected to mains in order to run LEDs Measure procedure.

Update software - The menu item allows you to update software in the fixture.

The following items are required in order to update software:

- PC running Windows or Linux or macOS
- DSU file
- Flash cable RS232/DMX, P/N13050624 (if you want to use a serial port of PC)
- Robe Universal Interface or Robe Universal interface WTX (if you want to use an USB port of PC)

After the software updating the fixture will be set to default values.

The following items are required in order to update software:

- PC running Windows or Linux or macOS
- DSU file
- Flash cable RS232/DMX, P/N13050624 (if you want to use a serial port of PC)
- Robe Universal Interface or Robe Universal interface WTX (if you want to use an USB port of PC)

After the software updating the fixture will be set to default values.

To update software in the fixture:

1. DSU file is available from Robe web site at WWW.robe.cz.
 - File with extension zip is intended for Windows (used and tested from XP to W10 on 32/64bit systems).
 - File with extension tbz is intended for Linux (used and tested on Debian and Ubuntu 32/64bit).
 - File with extension dmg is intended for macOS (used and tested on OSX up to Sierra) XQuartz required, install it from <https://www.xquartz.org/>
 - Save the download file to a folder on your computer.
 - In case that you use windows, extract files in the zip file (e.g. DSU_RobinPainte_21091633.zip)
2. Disconnect the fixture from DMX controller.
3. If you use the flash cable RS232/DMX, connect a serial port of your computer with DMX input of the fixture by means of the cable.
 - If you use the Robe Universal Interface, connect a USB port of your computer with the Robe Universal Interface by means of the USB cable and DMX input of the fixture with the DMX output of the Robe Universal Interface via a DMX cable.
4. Switch the fixture to the update mode (Special -> "SW Upd "-> On).
 - Note: If you do not want to continue in the software update, you have to switch off and on the fixture to escape from the updating mode.
 - We recommend to cancel all running programs on your computer before starting the software update.
5. Double-click the software uploader file (e.g. DSU_RobinPainte_21091633.exe) in the extracted files. The Software Uploader program will start to run.

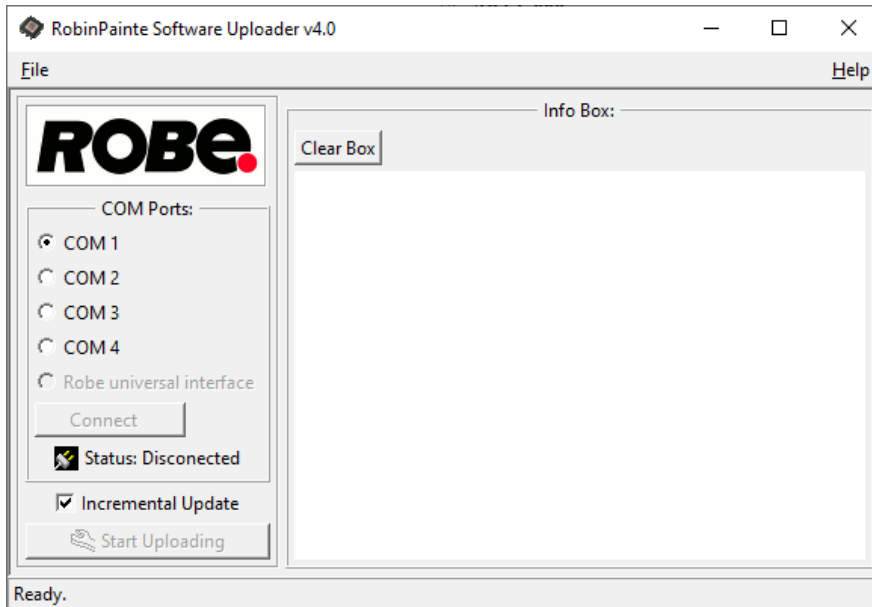

6. Select correct "COM " number if you use a Flash cable RS232/DMX or select "Robe Universal Interface " if you use the Robe Universal Interface/Robe Universal Interface WTX and then click on the "Connect" button.
 7. If the connection is OK, click the "Start Uploading" button to start software uploading. It will take several minutes to perform software update.
 If the option "Incremental Update" is not checked, all processors will be updated (including processors with the same software version).
 If you wish to update only processors with new version of software, check the "Incremental Update box".
 Avoid interrupting the process. Update status is being displayed in the "Info Box" window.
 When the update is finished, the line with the text "Fixture is successfully updated" will appear in this window.
- In case upload process is interrupted (e.g. power loss), the fixture stays in "Updating mode" and you will have to repeat the software update again.

Another way, how to update software in the fixtures (especially large installation of fixtures) is to use the ROBE Uploader. It is a software for automatized software update of Robe fixtures. It takes advantage of RDM support).

For more information please see <https://www.robe.cz/robe-uploader/>.

7. RDM

This fixture supports RDM operation. RDM (Remote Device Management) is a bi-directional communications protocol for use in DMX512 control systems, it is the new open standard for DMX512 device configuration and status monitoring.

The RDM protocol allows data packets to be inserted into a DMX512 data stream without adversely affecting existing non-RDM equipment. By using a special „Start Code,“ and by complying with the timing specifications for DMX512, the RDM protocol allows a console or dedicated RDM controller to send commands to and receive messages from specific moving lights.

RDM allows explicit commands to be sent to a device and responses to be received from it.

The list of commands for Robin Painte is the following.

Parameter ID	Discovery command	SET command	GET command
DISC_UNIQUE_BRANCH	*		
DISC_MUTE	*		
DISC_UN_MUTE	*		
DEVICE_INFO			*
SUPPORTED_PARAMETERS			*
SOFTWARE_VERSION_LABEL			*
DMX_START_ADDRESS		*	*
IDENTIFY_DEVICE		*	*

DEVICE_MODEL_DESCRIPTION			*
MANUFACTURER_LABEL			*
DEVICE_LABEL		*	*
SENSOR_DEFINITION			*
SENSOR_VALUE			*
DISPLAY_INVERT		*	*
DISPLAY_LEVEL		*	*
PAN_INVERT		*	*
TILT_INVERT		*	*
DEVICE_RESET		*	
DMX_PERSONALITY		*	*
DMX_PERSONALITY_DESCRIPTION			*
STATUS_MESSAGES			*
STATUS_ID_DESCRIPTION			*
DEVICE_HOURS			*
PARAMETER_DESCRIPTION			*
ROBE_DMX_INPUT		*	*
ROBE_WIRELESS_UNLINK		*	

RDM model ID for the Robin Painte is 0x0127.

8. Error and information messages

Information icon

- Air Filters Cleaning

This icon signals that cleaning period of the air filters has elapsed and you have to clear air filter and reset the menu item "Elapsed Time".

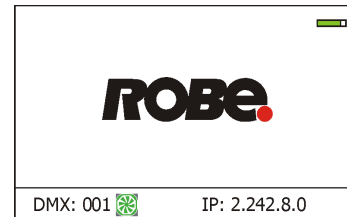

Errors

Error in the fixture is signalled by the yellow warning icon at the bottom line of the screen:



Touch the warning icon or press the [ESCAPE] button to display error messages.

List of error and information messages:

Tilt Error 1 (Tilt Error 2)

This message will appear after the reset of the fixture if the head's indexing circuit malfunctions (sensor failed) or the stepping motor or its driving PCB is defective. The head is not located in the default tilt position after fixture reset.

Pan Error 1 (Pan Error 2)

This message will appear after the reset of the fixture if the head's indexing circuit malfunctions (sensor failed) or the stepping motor or its driving PCB is defective. The head is not located in the default pan position after fixture reset.

Colour Wheel Error (Colour Wheel Error 2)

The messages will appear after the reset of the colour wheel if this wheel is not located in the default position.

Prism Error 1 (Prism Error 2)

The messages will appear after the reset of the prism wheel if this wheel is not located in the default position.

Iris Error 1 (Iris Error 2)

The messages will appear after the reset of the iris if the iris is not located in the default position.

Frost Error 1 (Frost Error 2)

The messages will appear after the reset of the frost module if this module is not located in the default position.

Zoom Error 1 (Zoom Error 2)

The messages will appear after the reset of the zoom module if the zoom lens is not located in the default position.

Focus Error 1 (Focus Error 2)

The messages will appear after the reset of the focus module if the focus lens is not located in the default.

Gobo Carousel Error 1 (Gobo Carousel Error 2)

The messages will appear after the reset of the rotating gobo wheel if this wheel is not located in the default position.

Gobo Rotation Error 1 (Gobo Rotation Error 2)

The messages will appear after the reset of the rotating gobo wheel if the rotating gobos are not located in the default positions.

Static Gobo Error 1 (Static Gobo Error 2)

The messages will appear after the reset of the static gobo wheel if this wheel is not located in the default position.

Fr. Shutters Rot. Error 1 (Fr. Shutters Rot. Error 2)

The messages will appear after the reset of the framing shutters module if this module is not located in the default position.

Fr. Shutter 1 Error 1 (Fr. Shutter 1 Error 2)

The messages will appear after the reset of the framing shutters module if the frame 1 is not located in the default position.

Fr. Shutter 2 Error 1 (Fr. Shutter 2 Error 2)

The messages will appear after the reset of the framing shutters module if the frame 2 is not located in the default position.

Fr. Shutter 3 Error 1 (Fr. Shutter 3 Error 2)

The messages will appear after the reset of the framing shutters module if the frame 3 is not located in the default position.

Fr. Shutter 4 Error 1 (Fr. Shutter 4 Error 2)

The messages will appear after the reset of the framing shutters module if the frame 4 is not located in the default position.

EEPROM Error

Hardware error of the EEPROM.

Recharge The battery

The battery on the display board needs to be charged. Let the fixture on for cca 6 hrs.

Battery Faulty. Replace it.

The battery on the display board is exhausted and should be replaced immediately.

Pan/Tilt EMS Cal. Error

The EMS system is not calibrated.

Pan/Tilt EMS Error

Control electronics cannot communicate with the EMS system.

Internal Error 1

Communication error between PCBs (error or noise was detected on communication wires)

Internal Error 2

Communication error (some PCB has failed or is disconnected (this PCB will show as N/A in menu --> Information --> Software versions) or error/noise was detected on communication wires)

Clean Air Filters

The message informs you that the item "Elapsed Time" in the "Fixture Information" menu is at 0 value. Clean air filter and reset this counter.

Overheated

The LED engine is overheated and light output is closed.

9. Technical Specifications

Electrical

Power supply: electronic auto-ranging
 Input voltage range: 100-240V, 50-60Hz
 Fuse: T 6.3A/250V ~
 Max. power consumption: 440W (power factor 0.98)
 Mains input: - max. 16A (US 13A)

Optic

Light source: TE™ 310W HP White LED Engine:
 Colour temperature: 6700K
 Fixture total lumen output: 6.500 lm (goniophotometer)
 Remotely selectable filter for CRI 90
 Typical lumen maintenance: L70/B50 @ 50.000 hours
 Light source warranty: 4 years or 20.000 hours

Colour wheel

9 dichroic filters (including one multicolour filter) + open

CMY colour mixing

Smooth CMY colour mixing system

Static gobo wheel

9 metal gobos

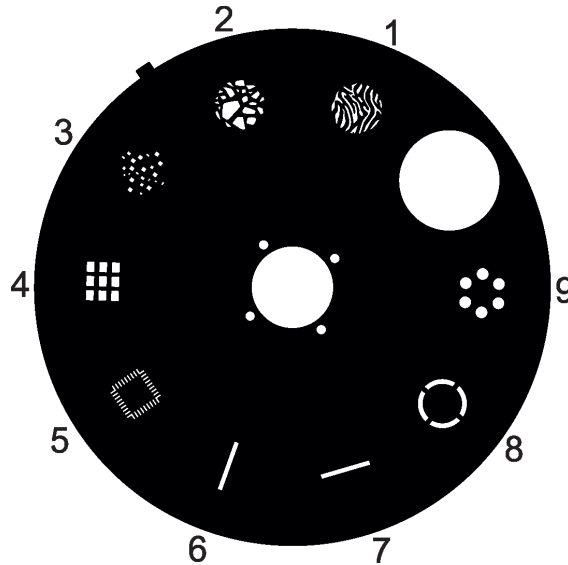

Rotating gobo wheel

8 glass gobos can be indexed and rotated in both directions at different speeds
 Gobo wheel continuous rotation

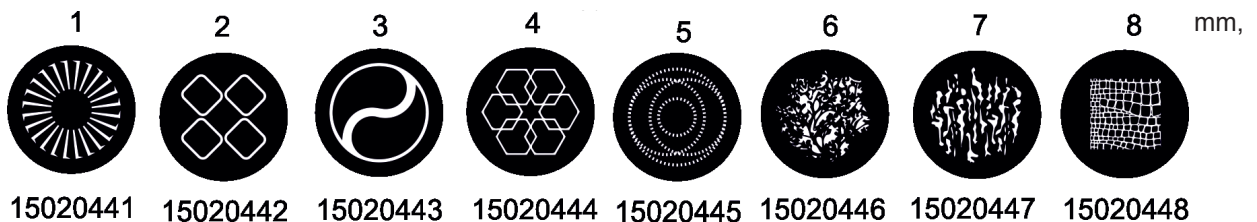

Prism

8-facet rotating prism with continuous rotation in both directions

Frost filter

Frost filter 5°

Zoom

Motorized zoom 8° - 48°

Focus

Motorized focus allows to focus beam from approx. 2 meters to infinity.

Framing shutters module

4 individually positionable shutters rotation of the complete frame system +/- 60°
Each framing shutter can be swiveled

Strobe

Strobe effect with variable speed (0.3 - 20Hz)

Dimmer

Smooth dimmer from 0 - 100 %

Pan/Tilt

Pan movement range 540°
Tilt movement range 270°
16 bit movement resolution
Automatic Pan/Tilt position correction
Pan/Tilt electronic motion stabilizer
Remotely controllable speed of pan/tilt

Control

Graphic touch screen for fixture setting and addressing
Gravitation sensor for auto screen positioning
Battery backup of the touch screen
Readout fixture usage, receiving DMX values, temperatures, etc
Built-in analyzer for easy fault finding, error messages
Silent fans cooling,
Stand-alone operation
3 user editable programs, each up to 40 steps
Supported protocols: USITT DMX 512, RDM, ArtNet, MA Net, MA Net2, sACN
1 DMX mode (44 control channels)

External Wireless DMX/RDM module (option)

Compliance with USITT DMX-512 (1986 & 1990) and 512-A
Full DMX fidelity and frame integrity
Auto sensing of DMX frame rate and frame size
<5ms DMX latency
Operational frequency range of 2402-2480 MHz
Producer: LumenRadio

Max. number of fixtures in Ethernet IN/Out line

8

Connection

DMX data in/out: Locking 5-pin XLR
Ethernet In/Out: 2 x RJ 45 (Robin Painte EP only)
Power IN: Neutrik powerCON TRUE1
Power OUT: Neutrik powerCON TRUE1

Rigging

Mounting points: 2 pairs of 1/4-turn locks
Mounting horizontally or vertically via two Omega holders

Temperatures

Maximum ambient temperature : 45° C
Maximum housing temperature : 70° C

Distances

Min. distance from flammable surfaces: 0.5 m
Min. distance to lit object: 3 m

Total heat dissipation

max. 1126 BTU/h (calculated)

Protection factor

IP20

Weight

19.6kg (43.2 lbs)

Dimensions (mm)

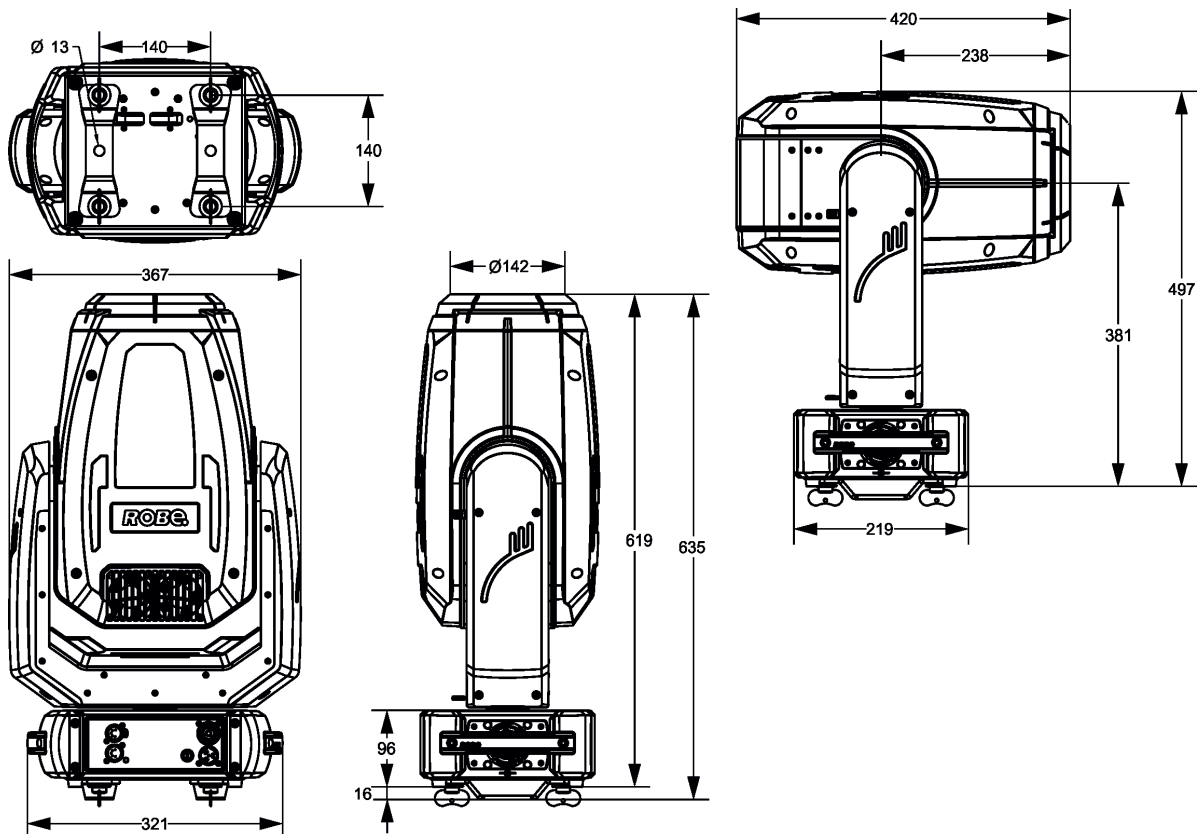

Accessories

- 1 x Omega adapter CL-regular 2 pcs in box (P/N 10980033)
- 1 x User manual

Optional accessories

- (P/N 1305 2405) Mains Cable PowerCon In TRUE1/Schuko, 2m, indoor
- (P/N 1305 2406) Mains Cable PowerCon In TRUE1/US, 2m, indoor
- (P/N 1305 2407) Mains Cable PowerCon In TRUE1/open ended, 2m, indoor
- (P/N 13052445) Mains Cable PowerCon In TRUE1/CEE 16A, 2m, indoor
- (P/N 1305 2439) Daisy Chain PowerCon TRUE1 In/Out, EU, 2m, indoor
- (P/N 1305 2440) Daisy Chain PowerCon TRUE1 In/Out, US, 2m, indoor
- (P/N 13052444) Daisy Chain PowerCon TRUE1 In/Out, EU, 5m, indoor
- (P/N 10980690) Frost 0.5° (exchange) assembled
- (P/N 10980691) Frost 1° (exchange) assembled
- (P/N 10980693) Frost 10° (exchange) assembled
- (P/N 10980694) Frost 20° (exchange) assembled
- (P/N 109806915) Frost 30° (exchange) assembled
- (P/N 10980033) Omega Adaptor CL-regular 2 pcs
- (P/N 17030386) Doughty Trigger Clamp
- (P/N 99011963) Safety wire 36 kg

10. Maintenance and cleaning

DANGER !
***Disconnect from the mains before starting any
maintenance work***

Never use alcohol or solvents for cleaning the front lens and covers of the fixture

It is absolutely essential that the fixture is kept clean and that dust, dirt and smoke-fluid residues must not build up on or within the fixture. Otherwise, the fixture's light output will be significantly reduced. Regular cleaning will not only ensure the maximum light output, but will also allow the fixture to function reliably throughout its life. A soft lint-free cloth moistened with any good glass cleaning fluid is recommended, under no circumstances should alcohol or solvents be used!

Front lens may require weekly cleaning as smoke-fluid tends to building up residues, reducing the light output very quickly. The cooling fans should be cleaned according to the situation (at least annually). The interior of the head and base should be cleaned at least annually using a vacuum-cleaner.

Periodically clean the air filter placed in the fixture base. This air filter is placed under a grille, which is fastened by means of two magnets.

Use a vacuum cleaner, compressed air or you can wash them and put back dry.

After replacing the air filter, reset the elapsed time counter in the tab "Information" (Information--->Air Filters--->Elapsed Time).

More complicated maintenance and service operations are only to be carried out by authorized distributors.

10.1 Replacing the fuse

Before replacing the fuse, unplug mains lead!

1. Remove the fuse holder on the rear panel of the base with a fitting screwdriver from the housing (anti-clockwise).
2. Remove the old fuse from the fuse holder.
3. Install the new fuse in the fuse holder (only the same type and rating).
4. Replace the fuseholder in the housing and fix it.

10.2 Checking plastic parts of the fixture

The plastic parts of the fixture should be checked for damages and beginning cracks at least every two months. If hint of a crack is found on some plastic part, do not use the fixture until the damaged part will be replaced. Cracks or another damages of the plastic parts can be caused by the fixture transportation or manipulation and also ageing process may influence plastic materials.

This checking is necessary for both fixed installations and preparing fixtures for renting. Any free moving parts inside of the fixture or any cracked plastic not sitting properly in place need to be immediately replaced.

10.3 Disposing of the product

To preserve the environment please dispose or recycle this product at the end of its life according to the local regulations and codes.

11. ChangeLog

This section summarizes changes in the user manual.

Version of the manual	Date of issue	Description of changes

March 31, 2022

Copyright © 2021-2022 Robe Lighting - All rights reserved

Specifications are subject to change without notice.

Made in ROBE Lighting s.r.o., Palackého 416, 757 01 Valašské Meziříčí, Czech Republic



12. Appendix

12.1 Changing the LED light source

The Robin Painte allows you to change the LED light source and this way keep a high performance of the fixture.

To change the LED light source.

1. Disconnect the fixture from mains and allow it to cool about 30 minutes.
2. Remove both head covers of the fixture and lock the head in a horizontal position in which you will have access to the LED control PCB (1).
3. Remove the rear cover (3) of the head by unscrewing the four screws M3x8 (2) with star washers.
4. Cut off the cable binder (4) and release the LED source cable (5). Disconnect the cable connector (6) from the LED control PCB (1).
5. Unscrew the four socket cap screws M4x14 (7) with washers and carefully remove the LED module (8) from the head (9).

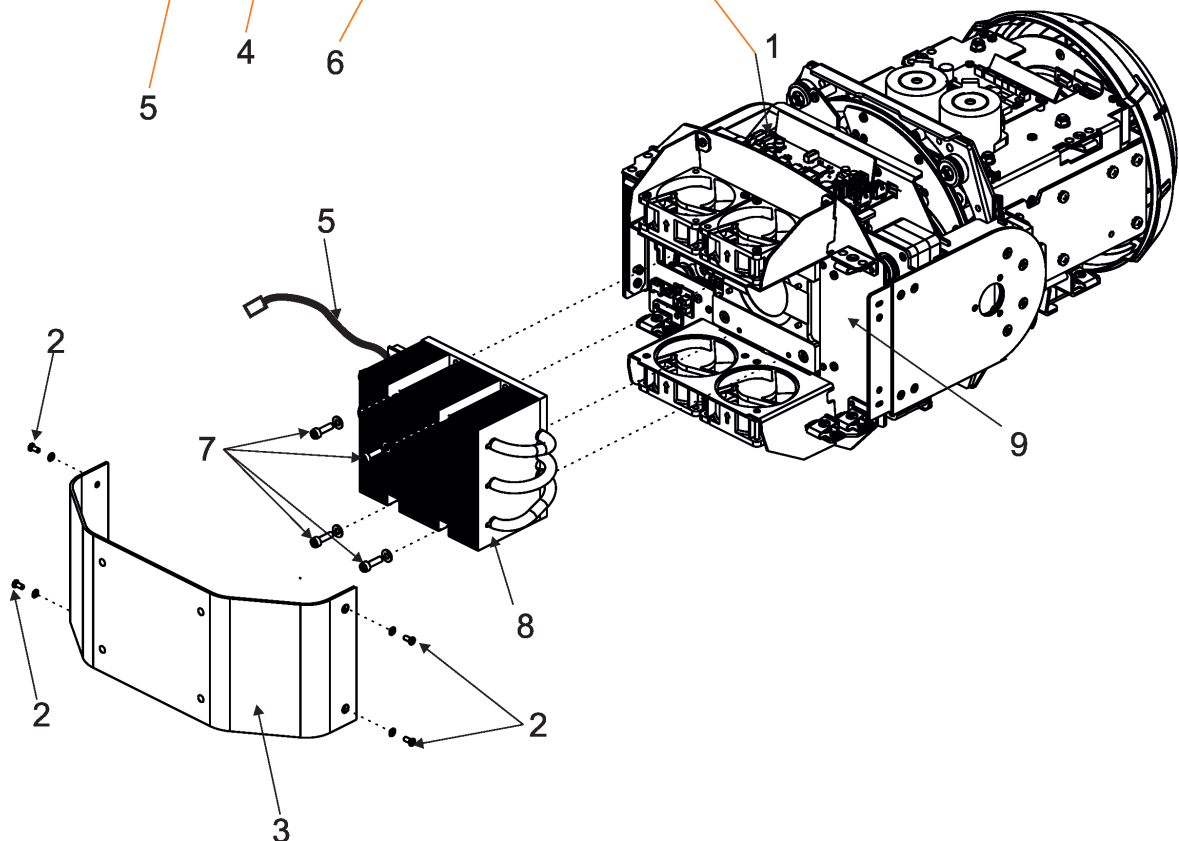
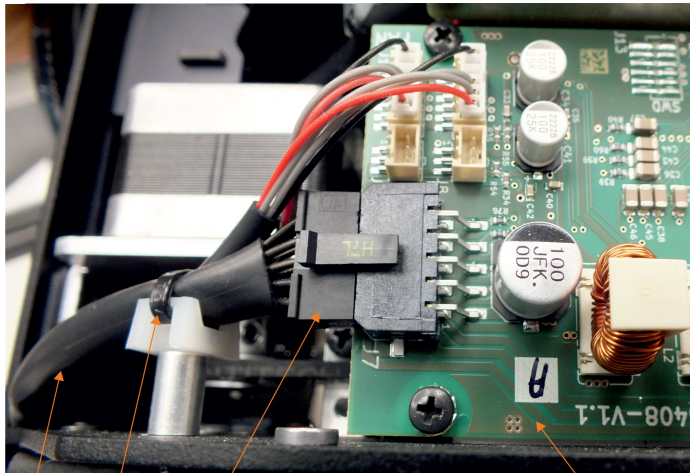

The LED module consists of the LED PCB (A) with LED source cable and the heatsink (B).

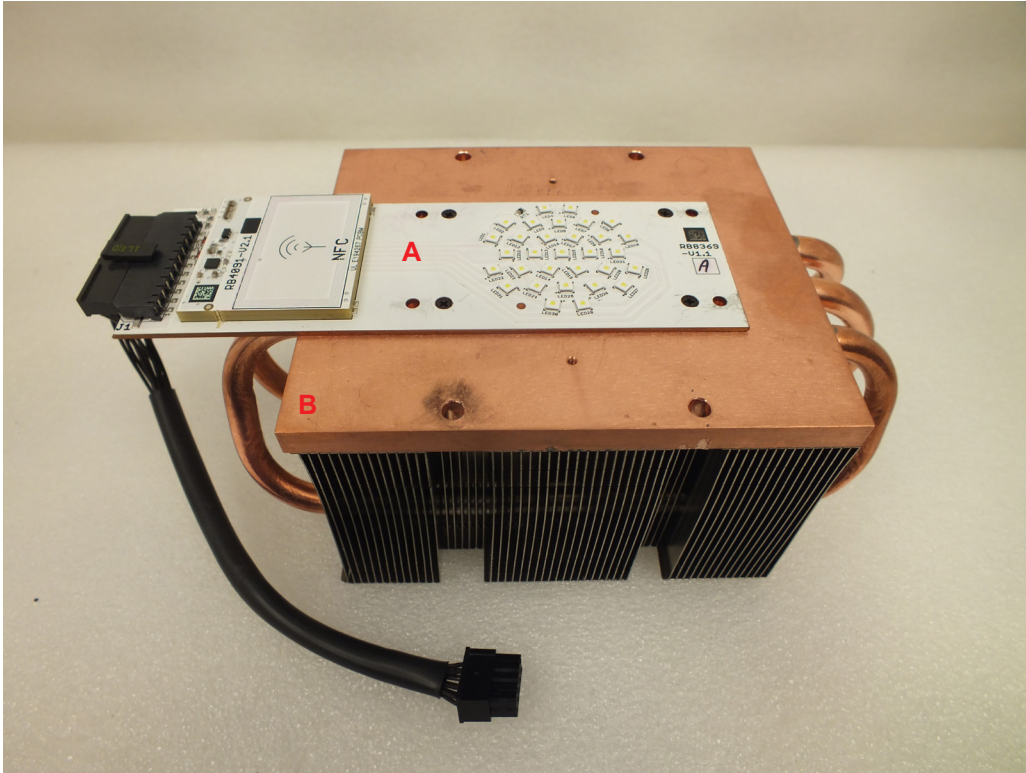

6. Screw the new LED module to the head by means of the four socket cap screws M4x14 (7) with washers
7. Connect the cable connector (6) to the control PCB. Fasten the cable (5) to the holder by means of the cable binder (4).
8. Screw the rear cover (3) back to the head by means of the four screws M3x8 (2) with star washers.
9. Fasten the head covers back on the head and check their attachment including securing wires.

12.2. Obtaining information about the LED light source by mobile phone

You can read information about the LED light source by means of the mobile application ROBE COM. The LED light source has to be outside of the fixture.

Download and install the application ROBE COM from Google Play (for Android 5.0 and higher) or App Store (for iOS 12.0 and higher) to your mobile phone. Your mobile phone has to support NFC (Near-Field Communication).

After installing the ROBE COM, run the application by touching the icon  .
The following screen will appear:

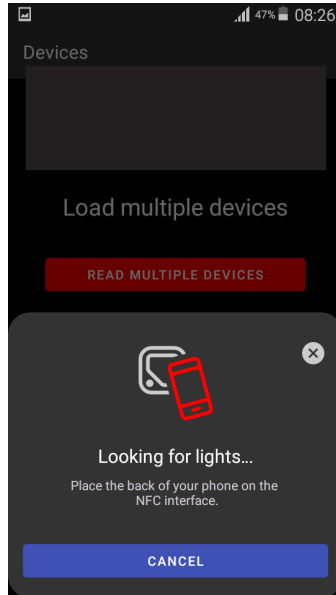

Hold the mobile phone close to the point of the LED PCB which is marked with the symbol NFC.

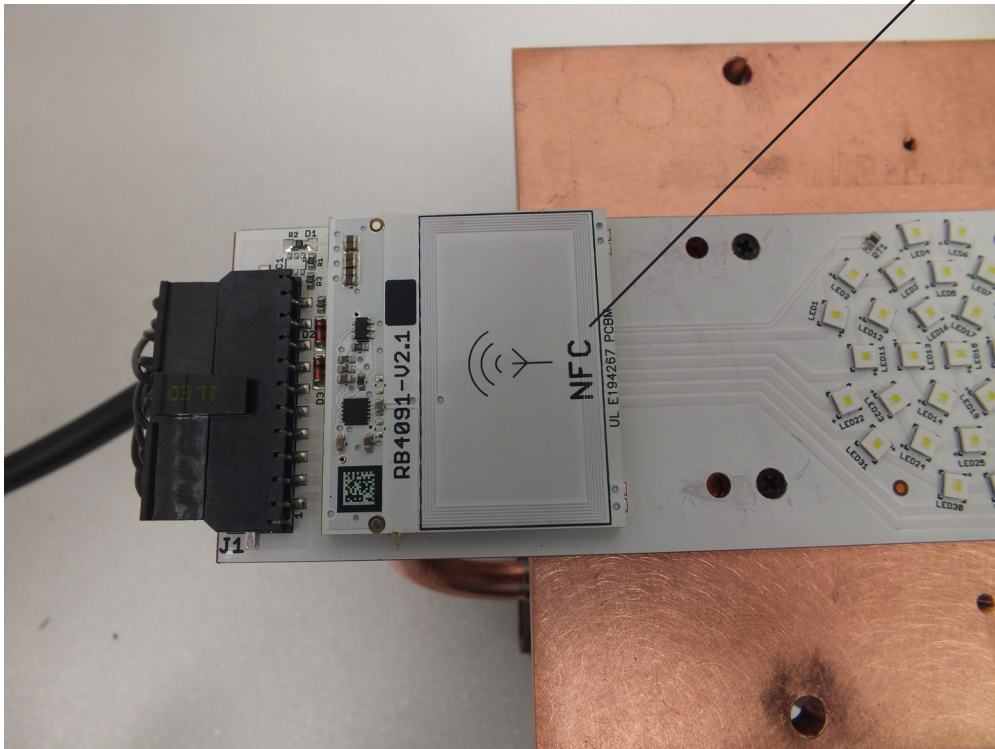

If NFC connection is OK, the following screens will appear.

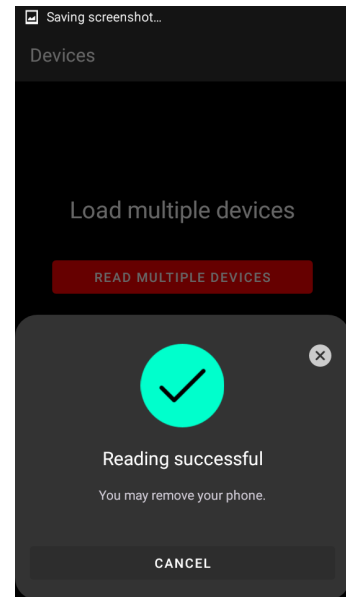
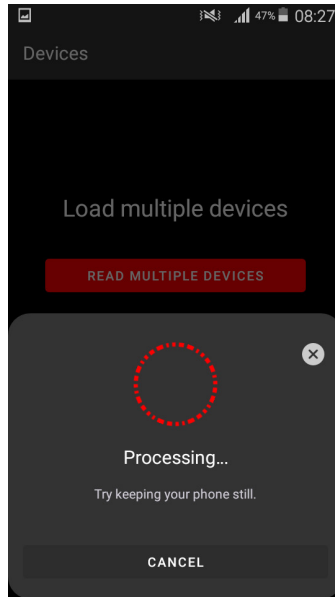
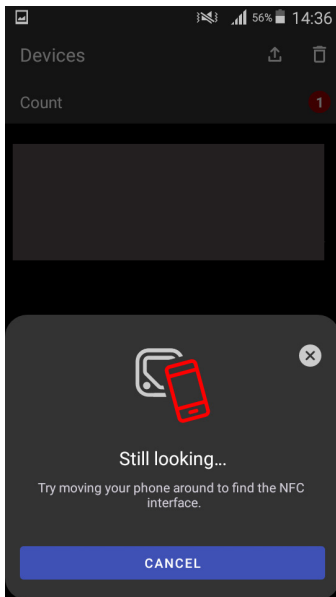

When the following screen will appear, touch the button CANCEL.

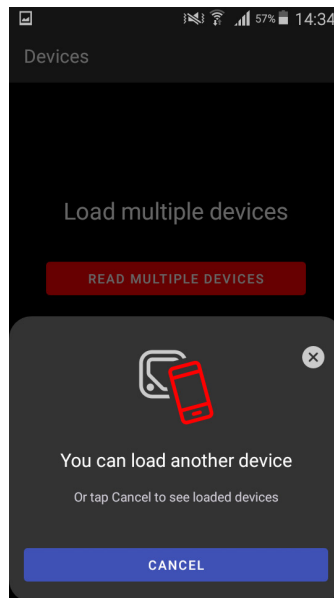

Touch the found LED module ("Robin Cuete LED module") and then touch "LED engine" to read information about found LED module.

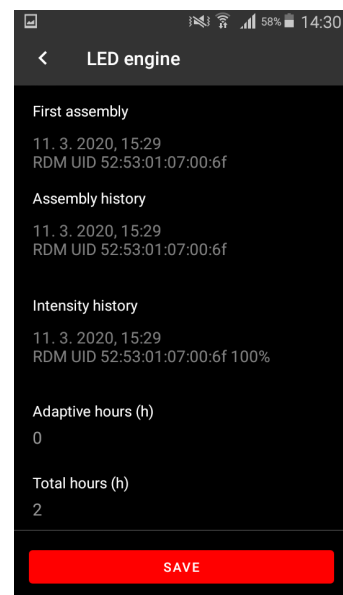
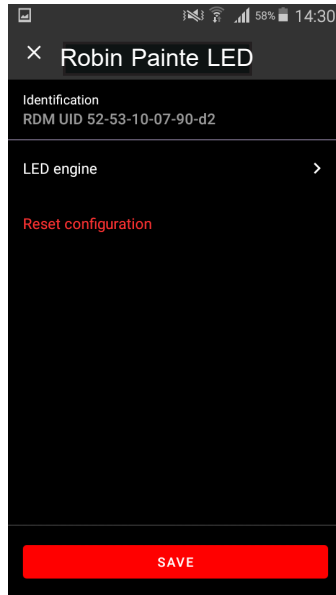
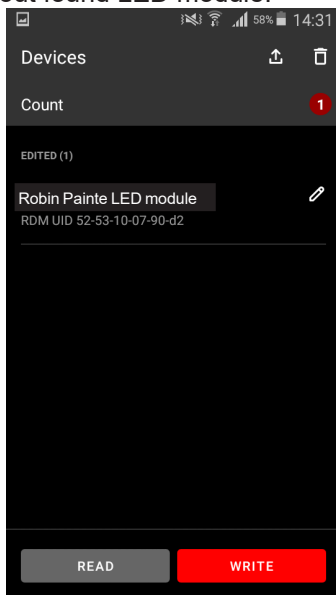

DMX protocol

Robin Painte Spot - DMX protocol			
Version 1.2			
Mode/Total channels	DMX Value	Function	Type of control
1/35			
1		Pan	
	0 - 255	Pan movement by 540° (128=default)	proportional
2		Pan Fine	
	0 - 255	Fine control of pan movement (0=default)	proportional
3		Tilt	
	0 - 255	Tilt movement by 270° (128=default)	proportional
4		Tilt fine	
	0 - 255	Fine control of tilt movement (0=default)	proportional
5		Pan/Tilt speed , Pan/Tilt time	
	0	Standard mode (0=default)	step
	1	Max. Speed Mode	step
		Pan/Tilt speed mode	
	2 - 255	Speed from max. to min.	proportional
		Pan/Tilt time mode	
	2 - 255	Time from 0.2 s to 25.5 sec.	proportional
6		Power/Special functions	
	0 - 9	Reserved (0=default) <i>To activate following functions, stop in DMX value for at least 3 s and shutter must be closed at least 3 sec. („Shutter,Strobe“ channel 33 must be at range: 0-31 DMX). Corresponding menu items are temporarily overridden.</i>	
	10-14	DMX input: Wired DMX *	step
	15-19	DMX input: Wireless DMX *	step
		* function is active only 10 seconds after switching the fixture on	
	20-24	Graphic display: On	step
	25-29	Graphic display: Off	step
	30-31	Quiet mode: Fans On at blackout	step
	32-33	Quiet mode: Fans Off at blackout	step
	34-35	Dimmer curve: Super Square Law	step
	36-39	Reserved	
	40-44	Pan/Tilt mode: Speed	step
	45-49	Pan/Tilt mode: Time	step
	50-54	Blackout while pan/tilt moving: On	step
	55-59	Blackout while pan/tilt moving: Off	step
	60-64	Blackout while gobo wheel moving: On	step
	65-69	Blackout while gobo wheel moving: Off	step
	70-74	Blackout while colour wheel moving: On	step
	75-79	Blackout while colour wheel moving: Off	step
	80-84	Fans mode: Auto	step
	85-89	Fans mode: High	step
	90-99	Reserved	
	100-104	Focus Tracking: On	step
	105-109	Focus Tracking: Off	step
	110-114	Dimmer curve: Square law	step
	115-119	Dimmer curve: Linear	step
	120-124	Parking position: On	step
	125-129	Parking position: Off	step

DMX protocol

Mode/Total channels	DMX Value	Function	Type of control
1/35		<i>To activate following functions, stop in DMX value for at least 3 seconds.</i>	
	130 - 139	Total fixture reset (without pan/tilt)	step
	140 - 149	Pan and Tilt reset	step
	150 - 159	Colour system reset	step
	160 - 169	Gobo wheels reset	step
	170 - 174	Pan reset	step
	175 - 179	Tilt reset	step
	180 - 189	Zoom/focus/frost/prism reset	step
	190 - 199	Iris reset	step
	200 - 209	Total fixture reset (including pan/tilt)	step
	210 - 218	Reserved	
		The following three commands define transition from gobo rotation to gobo indexing:	
	219 - 220	Gobo indexing: Maximum speed and shortcut	step
	221 - 222	Gobo indexing: Follow speed and direction	step
	223 - 224	Gobo indexing: Maximum speed and follow direction	step
		The following RoboSpot related commands are only applicable when the RoboSpot is connected:	
	225 - 229	RoboSpot enabled	step
	230 - 234	RoboSpot disabled - except handle faders and pan/tilt	step
	235 - 239	RoboSpot fully disabled	step
	240	Disabled "Quiet mode"	step
	241 - 255	Quiet mode - fan noise control from min. to max.	proportional
7		LED frequency selection	
		Factory display menu setting: 600Hz	
		<i>Select PWM output frequency of LEDs. Selected PWM frequency can be fine adjusted in 127 steps up/down around selected PWM frequency on the channel below. Corresponding menu item is temporarily overridden.</i>	
	0-4	PWM frequency from Display menu (fixture utilizes PWM frequency set in the display menu item Frequency Setup).	step
	5-9	300 Hz	step
	10-14	600 Hz (10=default)	step
	15-19	1200 Hz	step
	20-24	2400 Hz	step
	25-29	High	step
	30-255	Reserved (fixture utilizes PWM frequency set in the display menu item Frequency Setup).	
8		LED frequency fine adjusting	
		Factory display menu setting: 600Hz	
		<i>Select desired PWM output frequency of LEDs on the channel above.</i>	
	0-1	Selected LED Frequency	step
	2	LED Frequency (step -126)	step
	3	LED Frequency (step -125)	step
	4	LED Frequency (step -124)	step
	:		
	125	LED Frequency (step -3)	step
	126	LED Frequency (step -2)	step
	127	LED Frequency (step -1)	step

DMX protocol

Mode/Total channels	DMX Value	Function	Type of control
1/35			
	128	Selected LED Frequency (128=default)	step
	129	LED Frequency (step +1)	step
	130	LED Frequency (step +2)	step
	131	LED Frequency (step +3)	step
	:		
	252	LED Frequency (step +124)	step
	253	LED Frequency (step +125)	step
	254	LED Frequency (step +126)	step
	255	Selected LED Frequency	step
9		Max. light intensity indication and setting	
	0-10	No function (0=default)	
	11-20	Indication of drop of max. light intensity	step
		<i>A drop of max. light intensity of the fixture (compared to its original intensity) is indicated by a corresponding colour output: 0-5%, (WHITE /new LED module/) 6-10% (RED) 11-15% (GREEN) 16-20% (BLUE) 21-25% (CYAN) 26-30% (MAGENTA) 31-35% (YELLOW) 36-40% (ORANGE) Pan/tilt is set at 128 DMX (50%), Dimmer is open at 255 DMX (100%).</i>	
		<i>To set a drop of max. light intensity (compared to original light intensity), stay at DMX value for at least 3 sec. and shutter must be closed at least 3 sec. (Channel 33 „Shutter/Strobe” must be at range: 0-31 DMX). Corresponding menu items are permanently overwritten.</i>	
	21-30	Set drop by 6-10% (RED)	step
	31-40	Set drop by 11-15% (GREEN)	step
	41-50	Drop by 16-20% (BLUE)	step
	51-60	Set drop by 21-25% (CYAN)	step
	61-70	Set drop by 26-30% (MAGENTA)	step
	71-80	Set drop by 31-35% (YELLOW)	step
	81-90	Set drop by 36-40% (ORANGE)	step
	91-100	Original intensity (WHITE)	step
	101-255	Reserved	
10		Colour wheel	
		Continual positioning	
	0	Open/white	proportional
	12	Deep red	proportional
	25	Deep blue	proportional
	39	Light green	proportional
	51	Lavender	proportional
	64	Orange	proportional
	77	Multicolor	proportional
	90	Filter CRI 90	proportional

DMX protocol

Mode/Total channels	DMX Value	Function	Type of control
1/35			
	103	CTO 3200K	proportional
	115	Congo blue	proportional
	128-129	White	step
		Positioning	
	130-136	Deep red	step
	137-142	Deep blue	step
	143-149	Light green	step
	150-155	Lavender	step
	156-162	Orange	step
	163-168	Multicolor	step
	169-175	Filter CRI 90	step
	176-182	CTO 3200K	step
	183-189	Congo blue	step
	190 - 215	Forwards rainbow effect from fast to slow	proportional
	216 - 217	No rotation	step
	218 - 243	Backwards rainbow effect from slow to fast	proportional
	244 - 249	Random colour selection by audio control (Set microphone sensitivity in menu „Personality“)	step
	250 - 255	Auto random colour selection from fast to slow	proportional
11		Colour wheel - fine positioning	
	0 - 255	Fine positioning (0=default)	proportional
12		Cyan	
	0 - 255	Cyan from min. saturation --> full cyan (0=default)	proportional
13		Magenta	
	0 - 255	Magenta from min. saturation --> full magenta (0=default)	proportional
14		Yellow	
	0 - 255	Yellow from min. saturation --> full yellow (0=default)	proportional
15		Virtual CTO	
	0-255	Colour temperature change from 6700K --> 2700K (0=default)	proportional
16		Green correction	
	0	Uncorrected white	step
	1-127	Minus green --> uncorrected white	proportional
	128	Uncorrected white (128=default)	step
	129-255	Uncorrected white --> Plus green	proportional
17		Virtual colour wheel	
	0	No function (0=default)	step
	1-2	Filter 4 (Medium Bastard Amber)	step
	3-4	Filter 10 (Medium Yellow)	step
	5-6	Filter 19 (Fire)	step
	7-8	Filter 26 (Bright Red)	step
	9-10	Filter 58 (Lavender)	step
	11-12	Filter 68 (Sky Blue)	step
	13-14	Filter 71 (Tokyo Blue)	step
	15-16	Filter 79 (Just Blue)	step
	17-18	Filter 88 (Lime Green)	step
	19-20	Filter 90 (Dark Yellow Green)	step
	21-22	Filter 100 (Spring Yellow)	step
	23-24	Filter 101 (Yellow)	step

DMX protocol

Mode/Total channels	DMX Value	Function	Type of control
1/35			
	25-26	Filter 102 (Light Amber)	step
	27-28	Filter 103 (Straw)	step
	29-30	Filter 104 (Deep Amber)	step
	31-32	Filter 105 (Orange)	step
	33-34	Filter 106 (Primary Red)	step
	35-36	Filter 111 (Dark Pink)	step
	37-38	Filter 115 (Peacock Blue)	step
	39-40	Filter 116 (Medium Blue-Green)	step
	41-42	Filter 117 (Steel Blue)	step
	43-44	Filter 118 (Light Blue)	step
	45-46	Filter 119 (Dark Blue)	step
	47-48	Filter 120 (Deep Blue)	step
	49-50	Filter 121 (Filter Green)	step
	51-52	Filter 128 (Bright Pink)	step
	53-54	Filter 131 (Marine Blue)	step
	55-56	Filter 132 (Medium Blue)	step
	57-58	Filter 134 (Golden Amber)	step
	59-60	Filter 135 (Deep Golden Amber)	step
	61-62	Filter 136 (Pale Lavender)	step
	63-64	Filter 137 (Special Lavender)	step
	65-66	Filter 138 (Pale Green)	step
	67-68	Filter 139 (Primary Green)	step
	69-70	Filter 141 (Bright Blue)	step
	71-72	Filter 147 (Apricot)	step
	73-74	Filter 148 (Bright Rose)	step
	75-76	Filter 152 (Pale Gold)	step
	77-78	Filter 154 (Pale Rose)	step
	79-80	Filter 157 (Pink)	step
	81-82	Filter 158 (Deep Orange)	step
	83-84	Filter 162 (Bastard Amber)	step
	85-86	Filter 164 (Flame Red)	step
	87-88	Filter 165 (Daylight Blue)	step
	89-90	Filter 169 (Lilac Tint)	step
	91-92	Filter 170 (Deep Lavender)	step
	93-94	Filter 172 (Lagoon Blue)	step
	95-96	Filter 179 (Chrome Orange)	step
	97-98	Filter 180 (Dark Lavender)	step
	99-100	Filter 181 (Congo Blue)	step
	101-102	Filter 197 (Alice Blue)	step
	103-104	Filter 201 (Full C.T. Blue)	step
	105-106	Filter 202 (Half C.T. Blue)	step
	107-108	Filter 203 (Quarter C.T. Blue)	step
	109-110	Filter 204 (Full C.T. Orange)	step
	111-112	Filter 205 (Half C.T. Orange)	step
	113-114	Filter 206 (Quarter C.T. Orange)	step
	115-116	Filter 247 (Filter Minus Green)	step
	117-118	Filter 248 (Half Minus Green)	step
	119-120	Filter 281 (Three Quarter C.T. Blue)	step

DMX protocol

Mode/Total channels	DMX Value	Function	Type of control
1/35			
	121-122	Filter 285 (Three Quarter C.T. Orange)	step
	123-124	Filter 352 (Glacier Blue)	step
	125-126	Filter 353 (Lighter Blue)	step
	127-128	Filter 715 (Cabana Blue)	step
	129-130	Filter 778 (Millennium Gold)	step
	131-132	Filter 793 (Vanity Fair)	step
	133-255	Reserved	
18		CMY and Colour wheel time	
	0	Function is off (0=default)	step
	1 - 255	Time of CMY and Colour wheel movement (0.1sec-->25.5sec.)	proportional
19		Zoom/Focus/Frost/Iris/Prism time	
	0	Function is off (0=default)	step
	1 - 255	Time of zoom, focus, iris and frost movement (0.1 sec-->25.5 sec.)	proportional
	1-50	Time of prism movement (0.1 sec-->5 sec.)	proportional
20		Static gobo wheel	
	0-8	Open/hole	step
		<u>Positioning</u>	
	9-17	Gobo 1	step
	18-26	Gobo 2	step
	27-35	Gobo 3	step
	36-44	Gobo 4	step
	45-53	Gobo 5	step
	54-62	Gobo 6	step
	63-71	Gobo 7	step
	72-80	Gobo 8	step
	81-91	Gobo 9	step
		<u>Shaking gobos from slow to fast</u>	
	92-103	Gobo 1	proportional
	104-115	Gobo 2	proportional
	116-127	Gobo 3	proportional
	128-139	Gobo 4	proportional
	140-151	Gobo 5	proportional
	152-163	Gobo 6	proportional
	164-175	Gobo 7	proportional
	176-187	Gobo 8	proportional
	188-199	Gobo 9	proportional
	200-201	Open/hole	step
	202 - 222	Forwards gobo wheel rotation from fast to slow	proportional
	223 - 243	Backwards gobo wheel rotation from slow to fast	proportional
	244 - 249	Random gobo selection by audio control	step
		<i>(Set microphone sensitivity in menu „Personality“)</i>	
	250 - 255	Auto random gobo selection from fast to slow	proportional
21		Rotating gobo wheel	
		<i>Index - set indexing on channel 22</i>	
	0-9	Open/Hole (default)	step
	10-13	Gobo 1	step
	14-17	Gobo 2	step

DMX protocol

Mode/Total channels	DMX Value	Function	Type of control
1/35			
	18-21	Gobo 3	step
	22-25	Gobo 4	step
	26-29	Gobo 5	step
	30-33	Gobo 6	step
	34-37	Gobo 7	step
	38-41	Gobo 8	step
		<i>Rotation - set rotation on channel 22</i>	
	42-45	Gobo 1	step
	46-49	Gobo 2	step
	50-53	Gobo 3	step
	54-57	Gobo 4	step
	58-61	Gobo 5	step
	62-65	Gobo 6	step
	66-69	Gobo 7	step
	70-73	Gobo 8	step
		<i>Shaking gobos from slow to fast</i>	
		<i>Index - set indexing on channel 21</i>	
	74-81	Gobo 1	proportional
	82-89	Gobo 2	proportional
	90-97	Gobo 3	proportional
	98-105	Gobo 4	proportional
	106-113	Gobo 5	proportional
	114-121	Gobo 6	proportional
	122-129	Gobo 7	proportional
	130-137	Gobo 8	proportional
		<i>Shaking gobos from slow to fast</i>	
		<i>Rotation - set rotation on channel 22</i>	
	138-145	Gobo 1	proportional
	146-153	Gobo 2	proportional
	154-161	Gobo 3	proportional
	162-169	Gobo 4	proportional
	170-177	Gobo 5	proportional
	178-185	Gobo 6	proportional
	186-192	Gobo 7	proportional
	193-199	Gobo 8	proportional
	200 - 201	Open/hole	step
	202 - 222	Forwards gobo wheel rotation from fast to slow	proportional
	223 - 243	Backwards gobo wheel rotation from slow to fast	proportional
	244 - 249	Random gobo selection by audio control (Set microphone sensitivity in menu „Personality“)	step
	250 - 255	Auto random gobo selection from fast to slow	proportional
22		Rot. Gobo indexing/rotation	
		<i>Gobo indexing - set position on channel 21</i>	
	0 - 255	Gobo indexing (128=default)	proportional
		<i>Gobo rotation - set position on channel 21</i>	
	0	No rotation	step
	1 - 127	Forwards gobo rotation from fast to slow	proportional

DMX protocol

Mode/Total channels	DMX Value	Function	Type of control
1/35	128	No rotation (128=default)	step
	129 - 255	Backwards gobo rotation from slow to fast	proportional
23		Rot. Gobo indexing/rotation - fine	
	0-255	Fine indexing/rotation (0=default)	proportional
24		Prism	
	0 - 19	Open position/hole (0=default)	step
	20 - 73	Prism indexing	step
	74-127	Prism rotation	step
		Prism/gobo macros	
		<i>The following channels are blocked: Rotating gobo wheel, Rot. Gobo indexing and rotation, Rot. Gobo wheel fine rotation</i>	
	128 - 135	Macro 1	step
	136 - 143	Macro 2	step
	144 - 151	Macro 3	step
	152 - 159	Macro 4	step
	160 - 167	Macro 5	step
	168 - 175	Macro 6	step
	176 - 183	Macro 7	step
	184 - 191	Macro 8	step
	192 - 199	Macro 9	step
	200 - 207	Macro 10	step
	208 - 215	Macro 11	step
	216 - 223	Macro 12	step
	224 - 231	Macro 13	step
	232 - 239	Macro 14	step
	240 - 247	Macro 15	step
	248 - 255	Macro 16	step
25		Prism indexing/rotation	
		Prism indexing - set position on channel 24	
	0 - 255	Prism 1 indexing	proportional
		Prism rotation - set position on channel 24	
	0	No rotation	step
	1 - 127	Forwards prism rotation from fast to slow	proportional
	128	No rotation (128=default)	step
	129-255	Backwards prism rotation from slow to fast	proportional
26		Frost	
	0	Open (0=default)	step
	1 - 179	Frost from 0% to 100%	proportional
	180 - 189	100% frost	step
	190 - 211	Pulse closing from slow to fast	proportional
	212 - 233	Pulse opening from fast to slow	proportional
	234 - 255	Ramping from fast to slow	proportional
27		Iris	
	0	Open (0=default)	step
	1 - 179	From max. diameter to min. diameter	proportional
	180 - 191	Closed	step
		Pulse effects with Iris blackout	
	192 - 219	Pulse opening from slow to fast	proportional

DMX protocol

Mode/Total channels	DMX Value	Function	Type of control
1/35			
	220 - 247	Pulse closing from fast to slow	proportional
	248 - 249	Random pulse opening (fast)	step
	250 - 251	Random pulse opening (slow)	step
	252 - 253	Random pulse closing (fast)	step
	254 - 255	Random pulse closing (slow)	step
28		Iris - fine	
	0 - 255	Fine iris movement (0=default)	proportional
29		Zoom	
	0 - 255	Zoom from max. to min. beam angle (128=default)	proportional
30		Zoom - fine	
	0-255	Fine zooming (0=default)	proportional
31		Focus	
	0 - 255	Continuous adjustment from far to near (128=default)	proportional
32		Focus - fine	
	0- 255	Fine focusing (0=default)	proportional
33		Shutter/ strobe	
	0 - 31	Shutter closed	step
	32 - 63	Shutter open (32=default)	step
	64 - 95	Strobe-effect from slow to fast	proportional
	96 - 127	Shutter open	step
	128 - 143	Opening pulse in sequences from slow to fast	proportional
	144 - 159	Closing pulse in sequences from fast to slow	proportional
	160 - 191	Shutter open	proportional
	192 - 223	Random strobe-effect from slow to fast	proportional
	224 - 255	Shutter open	step
34		Dimmer intensity	
	0 - 255	Dimmer intensity from 0% to 100% (0=default)	proportional
35		Dimmer intensity - fine	
	0 - 255	Fine dimming (0=default)	proportional
Copyright © 2021-2022 Robe Lighting s.r.o. - All rights reserved			
All Specifications subject to change without notice			